

Salt Spray Cabinet

SF/xxx A: CW1000 series
SF/MPxxx: CW1100 series

SF/xxx/C: CW1200 series
SF/ABxxx: CW1700 series

SF/MP/ABxxx: CW1800 series

Operating Instructions (V2.0 1119)



IMPORTANT! Before taking this instrument in use we strongly advise you to read this manual carefully.

PRODUCT GUARANTEE

C&W Specialist Equipment guarantee the cabinet and components included in its manufacture for a period of one year from the date of despatch from its factory according to the shipping documents subject to the below mentioned conditions and excluding the items listed in condition 5 below. If within the said period any component of the cabinet is found to be defective, C&W Specialist Equipment will (subject to the conditions of the guarantee and excluded items) exchange or repair such a component free of charge to the end customer. In the event of a local distributor or agent representing C&W Specialist Equipment, the agent or distributor will be responsible for the repair or replacement of the faulty component. All labour and travelling costs incurred during the replacement will be absorbed by the agent or distributor. C&W Specialist Equipment will supply the replacement components without charge on condition that the said faulty component is returned to C&W Specialist Equipment at the expense of the agent) within the period of the guarantee.

This guarantee is to be additional to and does not take away any of the purchaser's rights under the Sale of Goods Act 1979. Neither does this guarantee supersede any guarantee given by the manufacturers whose services will be employed where appropriate.

Conditions of Guarantee

1. The cabinet has not been tampered with or repaired by anyone other than an employee or agent of C&W Specialist Equipment, unless under direct instructions from C&W Specialist Equipment.
 2. The cabinet has been installed correctly as per the instructions of C&W Specialist Equipment.
 3. The cabinet has not been subject to misuse, or to willful or accidental damage (including damage caused by fire or lightning).
 4. The cabinet has been used solely for the purpose for which it was manufactured and kept in and operated to the conditions specified by C&W Specialist Equipment.
 5. The guarantee excludes components that have a limited life span and components that are non mechanical or electrical that fail due to third party damage.
- Indicator Lamps
 - Fuses
 - Peristaltic Pump Tubing
 - Light Bulbs
 - Salt Solution Filters
 - Salt Fog Atomiser (Spray Nozzle)
 - All other consumable items.

INDEX

Declaration of Conformity	4
Salt Corrosion Cabinet	5
Installation	6
Rearview	7
Drainage	8
Construction	10
Operating	11
Starting to test	
Display panel	
Profile controller	12
Air purge function	
Programming	13
Profile controller troubleshooting	14
Checklist	
Profile controller Air Plurge	
Run program mode	15
Plumbing	16
Summary Of Astm B117	17
ASTM B117 pH range	
Adjusting the ph of salt solution	18
Checklist	
How to change the tubing on a peristaltic pump	19
Essential cabinet maintenance	21
Health and Safety at work act - Legionella	22
Troubleshooting	24
Disclaimer	

DECLARATION OF CONFORMITY **CE**

C&W Salt Spray Cabinets, Cyclic Salt Spray Cabinets, CCT Cabinets, Humidity Cabinets and Combination Cabinets are manufactured in Capelle aan den IJssel, Molenbaan 19, The Netherlands.

The manufacturer hereby declares under their sole responsibility that the products identified above comply with the protection requirements of the EMC directives with the principle elements of the safety objectives of the low voltage equipment directive and with the essential health and safety requirements of the machinery directive.

Directives Covered:

2004/108/EC	EMC Directive (89/336/EEC)
2006/95/EC	Low Voltage Directive (LVD) (72/23 EEC and 93/68 EEC)
2006/42/EC	Machinery Directive (98/37 EC 2009)
89/655/EEC	Use of Work Equipment Directive (PUWER 98)

Compliance: By meeting the following standards the equipment is in compliance of the above directives.

EN 61326-1-2006	Electrical Equipment for Measurement and Control and Laboratory use.
EN 61010-1-2001	Safety Requirements Electrical Equipment for Measurement, Control and Laboratory use.
EN 61010-2-010-2003	Particular Requirements for Laboratory Equipment for Heating of Materials.
EN 61010-1-2003	Safety Requirements for Electrical Equipment for Measurement Control and Laboratory use PART 1 : General Requirements.
EN 61000-6-2-2005	Electromagnetic Compatibility (EMC) Generic Standards. Immunity for industrial Environments.

The technical documentation required to demonstrate that the products meet the requirements of the Directives can be made available to the relevant authorities within a reasonable period of time.

The CE mark was first applied in 2007.

Signed: 

Date: 1 September 2019

Name: Remco Wever

Position: Managing Director

NOTES: The attention of the specifier, purchaser, installer or user is drawn to special measures and limitations to use that must be observed when the products are taken into service to maintain compliance with the above directives. Details of special measures and limitations to use are available on request and are contained in product manuals.

SALT CORROSION CABINET

Models

100 SF SF/MP SF/AB SF/AB/MP	200 SF SF/MP SF/AB SF/AB/MP	450 SF SF/MP SF/AB SF/AB/MP	750 SF SF/MP SF/AB SF/AB/MP	1000 SF SF/MP SF/AB SF/AB/MP	2000 SF SF/MP SF/AB
---	---	---	---	--	------------------------------

All CASS Models

Services Required

Mains Electricity

220/240V Single phase 50 Hz (current ratings vary subject to model type).

Model	Max Load	Overcurrent Protection Required
SF/100	1.4kw	13.0A
SF/MP100	1.4kw	13.0A
SF/AB100	2.2kw	13.0A
SF/MP/AB100	2.2kw	13.0A
SF/200	2.0kw	13.0A
SF/MP200	2.0Kw	13.0A
SF/AB200	2.2Kw	13.0A
SF/MP/AB200	2.2kw	13.0A
SF/450	2.5kw	13.0A
SF/MP450	2.5kw	13.0A
SF/AB450	2.2kw	13.0A
SF/MP/AB450	2.5kw	13.0A
SF/750	2.5kw	13.0A
SF/MP750	2.5kw	13.0A
SF/AB750	2.2kw	13.0A
SF/MP/AB750	2.5kw	13.0A
SF/1000	3.2kw	16.0A
SF/MP1000	3.2kw	16.0A
SF/AB1000	4.2kw	16.0A
SF/MP/AB1000	4.2kw	16.0A
SF/2000	4.0kw	16.0A
SF/MP2000	4.0kw	16.0A
SF/AB2000	4.2kw	16.0A
SF/MP/AB2000	4.2kw	16.0A

Water

A continuous supply of clean water should be connected to the cabinet during all times of operation.

Max Pressure permitted	4 Bar (58.4 p.s.i.)
Min Pressure permitted	2 Bar (29.4 p.s.i.)

NOTE: In areas with hard or mineral containing water, it is recommended that distilled or de-ionised water is used.

Drainage

All models of Salt Corrosion Cabinets are fitted with drain/vents. The drain/vent is a 1 ¼" (32mm) push on pipe fitting located in the base of the test chamber which is coupled up to a foul water drain system.

Compressed Air

A continuous dry and oil free air supply should be connected to the cabinet during all times of operation.

Average Setting	1 Bar (14.7 p.s.i.)
Max Air Pressure permitted	4 Bar (58.4 p.s.i.)
Min Air Pressure permitted	2 Bar (29.4 p.s.i.)

Air flow rates vary subject to model type.

SF/100	SF/MP/AB100	SF/AB100	} 3.6 S.C.F.M.	SF/MP100	} 4.2 S.C.F.M.
SF/200	SF/MP/AB200	SF/AB200		SF/MP200	
SF/450	SF/MP/AB450	SF/AB450		SF/MP450	
SF/750	SF/MP/AB750	SF/AB750		SF/MP750	
SF/1000	SF/MP/AB1000	SF/AB1000		SF/MP1000	
SF/2000		SF/AB2000		SF/MP2000	

INSTALLATION

The salt corrosion cabinet should be placed in a level position away from any external source of heat i.e. radiator, sunlight etc, and convenient to all required services.

A) 114 litre (200 litre for 2000 litre model cabinets) capacity reservoir is supplied on castors for salt solution and is usually placed to the right of the cabinet. However, should it not be possible to place the reservoir on the right, sufficient tubing is supplied to place it to the left of the cabinet.

Electrical

It will be necessary to locate these cabinets to within 2 metres of a 13A socket supply.

Models SF/1000 and SF/MP1000 (and SF/100, SF/MP100, SF200, SF/MP200, SF/450, SF/MP450, SF/750 and SF/MP750 supplied for export) are manufactured with a mains power connector box on the rear of the cabinet.

It will be necessary to connect a suitable cable (20A rated min) from the power in box to a wall mounted fused isolator.

Water, Air, Salt Solution and Air Relief

See diagram of the services in panel found on the rear of the cabinet.

Water

A) 3/8" reinforced hose should be used to connect the water supply to the 3/8" hose fitting labelled WATER on the services in panel (see diagram of services in panel).

Air

A) 3/8" reinforced hose should be used to connect the compressed air supply to the 3/8" hose fitting labelled AIR on the services in panel (see diagram of services in panel).

Salt Solution

The 6mm tubing from the salt solution reservoir should be connected to the compression fitting labeled salt solution on the services in panel (see diagram of services in panel).

Air Relief

A) 4mm pipe connected to the compression fitting labeled Air Relief on the services in panel (see diagram of services in panel) should be introduced into the salt waste pipe, via the grommet provided.

REARVIEW

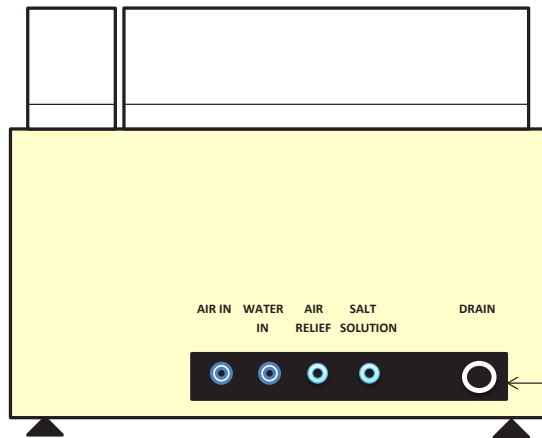

SF100 SERVICES INPUT PANEL

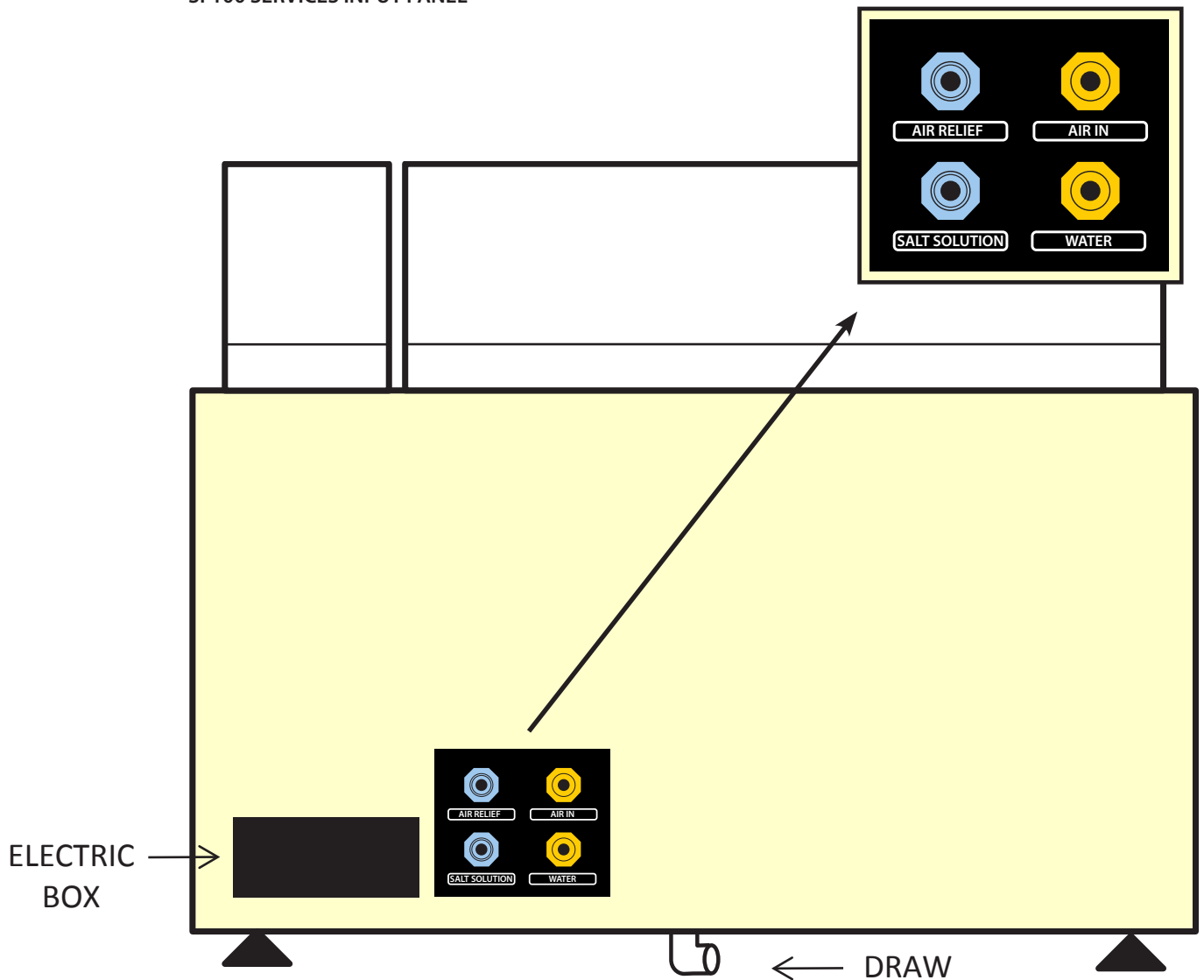

SF200 AND ON SERVICES INPUT PANEL

DRAINAGE

The drain/vent is a 1 ¼" (32mm) PUSH ON pipe fitting located in the base of the test chamber.

Excess salt solution (fallout) flows from the test chamber to a foul water drain.

It is necessary to couple up the 1 ¼" drain pipe to your foul water drain as shown in "Side view showing drainage" on the next page.

A vertical pipe out to atmosphere must be inserted within 1 metre or as close as possible of the cabinet to allow venting to take place.

NOTE: It is very important that a positive downhill slope is maintained all the way to the foul water drain. Failure to do so will result in the prevention of the cabinet from venting.

Should the cabinet fail to vent correctly pressure inside the test chamber will be forced out through the water seal seating the cabinet lid.

Once all the services are connected and the salt solution reservoir has been filled with salt solution, the cabinet can be switched on and testing may commence.

A series of air valves direct the air through the air regulator, through the humidifier tower (if moist air is selected) to the spray jet nozzle.

During a Fog Cycle if the Air Purge is selected the Fog Cycle circuit is disabled allowing the test chamber to purge clear by air entering the chamber via Air Purge nozzles at the top of the side walls and forcing the salt fog down through the drain pipe and out of the vent pipe.

Methods for drainage

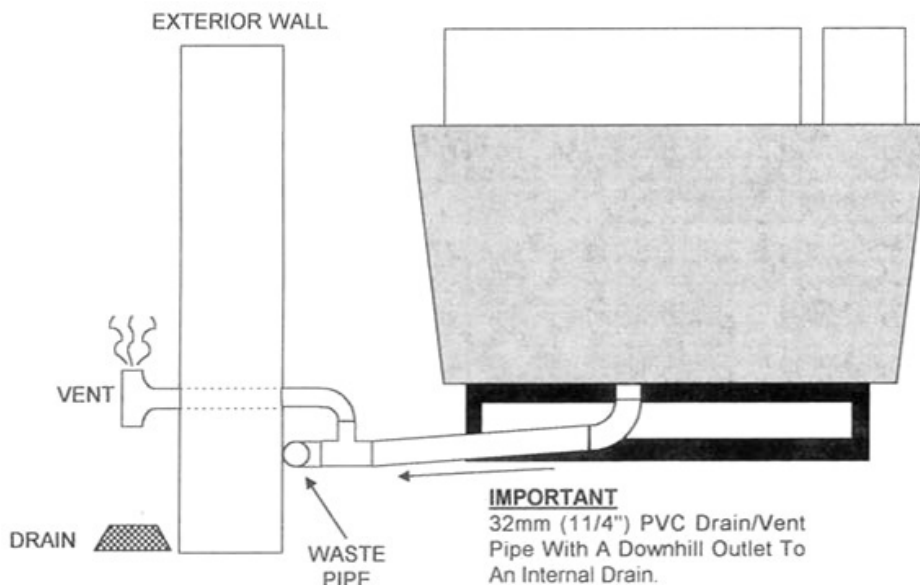
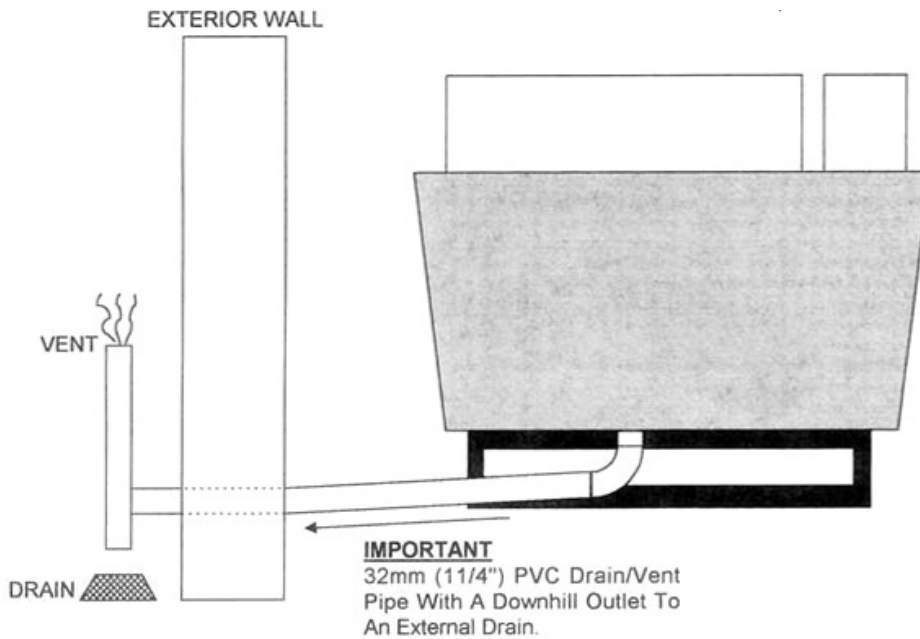

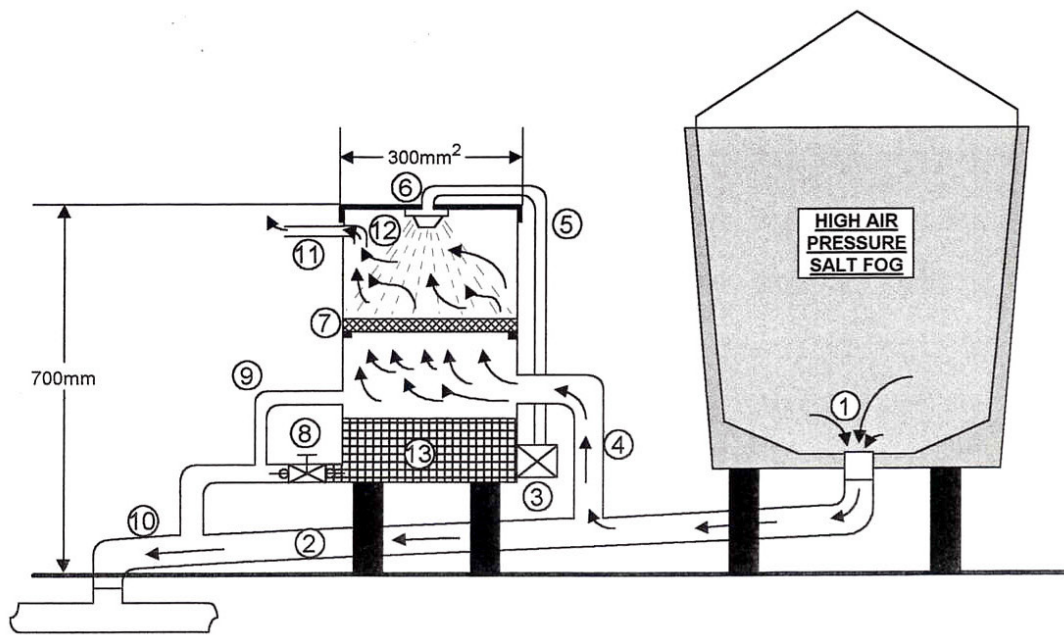
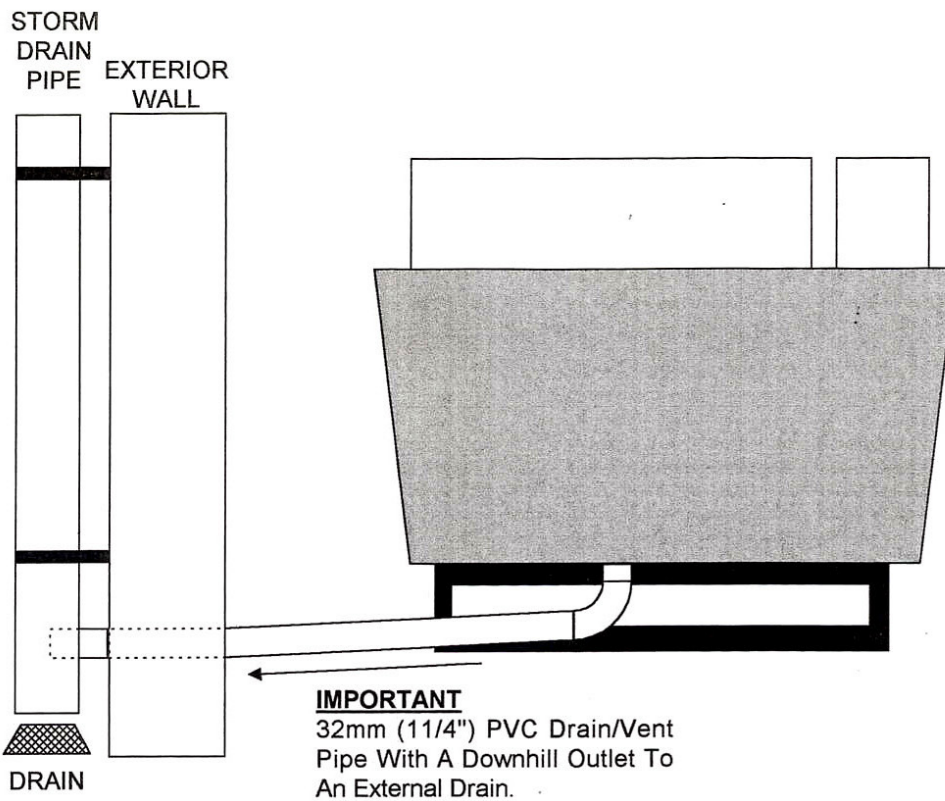

- | | | |
|---|-----------------|---------------------|
| 1 Combined Liquid Drain And Air Escape. | 6 Spray Nozzle. | 11 Clean Air Vent. |
| 2 Drain To Waste. | 7 Filter Bed. | 12 Baffle. |
| 3 Electric Pump. | 8 Drain Tap. | 13 Water Reservoir. |
| 4 Vent Breather Pipe. | 9 Overflow. | |
| 5 Water Spray Line | 10 Drain | |

Above is a fog box/scrubber which is used when no external ventilation is possible.

SIDE VIEW SHOWING 100L DRAINAGE

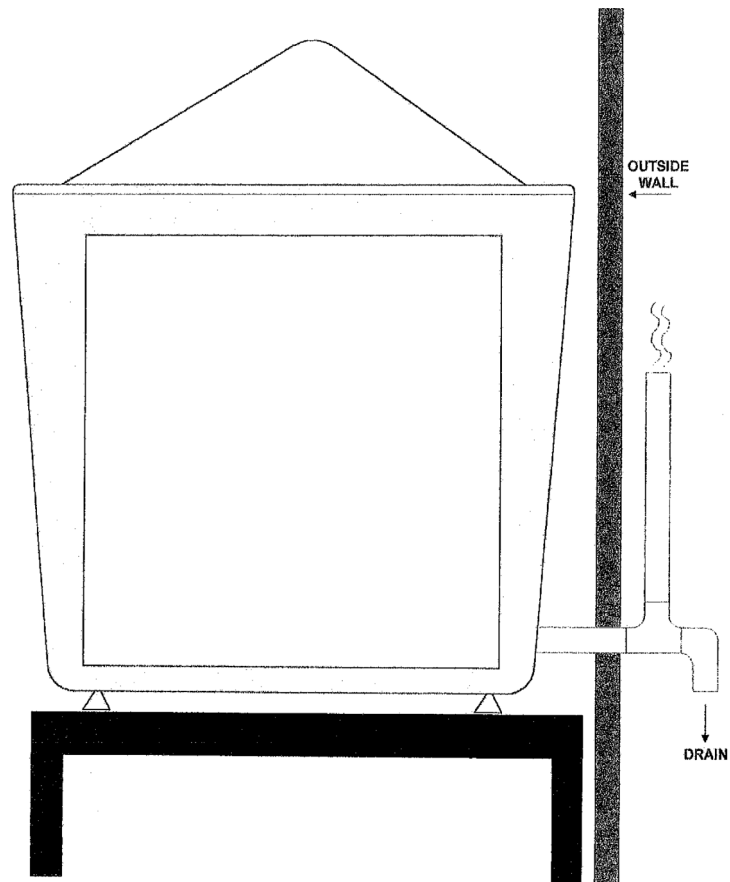

CONSTRUCTION

A salt corrosion cabinet is manufactured from Glass Reinforced Plastic (GRP).

It is constructed in two parts.

1. The Ivory outer shell 'cabinet outer' which houses the Control Chassis, Humidifier Tower, Flowmeter, Peristaltic Pump, Pump Speed Adjuster, Service Input Panel etc.
2. The Beige inner shell with console that houses the control panel 'cabinet inner' sits within the cabinet outer and has mounted on it the heater panels.

SF/100	SF/MP100	SF/MP/AB100	SF/AB100	4 Heater Panels
SF/200	SF/MP200	SF/MP/AB200	SF/AB200	4 Heater Panels
SF/450	SF/MP450	SF/MP/AB450	SF/AB450	4 Heater Panels
SF/750	SF/MP750	SF/MP/AB750	SF/AB750	4 Heater Panels
SF/1000	SF/MP1000	SF/MP/AB1000	SF/AB1000	6 Heater Panels
SF/2000	SF/MP2000		SF/AB2000	8 Heater Panels

Jet Assembly, Air Purge System, Drain/Vent, Heater Overcurrent Protection, Temperature Sensor, Overtemperature Protection, Sample Rack Supports.

OPERATING

Once all the services are connected and the salt solution reservoir is filled with salt solution you may commence testing.

Place your test samples on the sample racks inside the test chamber.

NOTE: Care must be taken when positioning the sample racks not to obstruct the jet nozzle spray path, or overhang the fallout collection vessels (minimum of 2 vessels required).

Pour fresh clean water into the water trough into which the lid will sit. The water seal will now prevent the escape of any fog during testing.

Close the lid.

If operating to ASTM B117 the chamber requires a humidity level of 95-98% RH during testing.

The required temperature of the water inside the humidifier tower depends on the air pressure at the spray jet nozzle.

ASTM B117 table X1.2 states

Air Pressure (p.s.i.)	14	16	18
Humidifier Temperature (°C)	47	48	49

DISPLAY PANEL

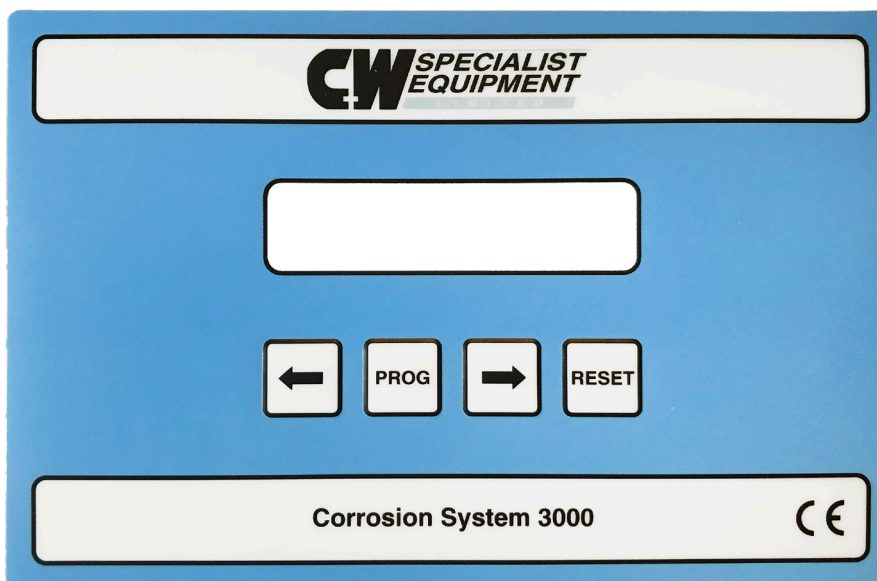

STARTING TO TEST

Allow 10 minutes for the salt solution to be drawn from the salt solution reservoir and be pumped to the spray jet nozzle.

This procedure may be accelerated by increasing the pump speed. To alter the pump speed, turn the adjuster knob positioned between the pump and the flowmeter.

Once the salt solution has reached the jet nozzle, set the flowrate on the flowmeter (by increasing or decreasing the pumpspeed regulator on the control panel)

to the value shown in the table below.

	Air Pressure	Flowrate
SF/100, SF/MP100, SF/MP/AB100	0.9 - 1 Bar	0.1 - 0.3 L/hr
SF/200, SF/MP200, SF/MP/AB200	0.9 - 1 Bar	0.3 - 0.4 L/hr
SF/450, SF/MP450, SF/MP/AB450	1.0 - 1.2 Bar	0.4 - 0.5 L/hr
SF/750, SF/MP750, SF/MP/AB750	1.3 - 1.4 Bar	0.7 - 0.8 L/hr
SF/1000, SF/MP1000, SF/MP/AB1000	1.3 - 1.4 Bar	0.7 - 0.8 L/hr
SF/2000, SF/MP2000, SF/MP/AB2000	1.5 - 1.8 Bar	1.0 - 1.2 L/hr

These figures are a guide only and may vary with each cabinet.

Using the settings shown in the above table should enable you to achieve a good even salt fog distribution, with fallout collection rates of 1-2 ml/hr 80cm of horizontal area.

Having followed all of the above instructions the cabinet will now operate fully automatically and function to your test specification.

PROFILE CONTROLLER

The controller can save 7 programs with a maximum of 20 segments per program.

To run a program

Before a program can be run one must be selected between 1 and 7 and loaded into the memory.

- After switching on the machine select function appears in the controller window.
- Press either the left or right arrow keys and you will get **'1 program' or '2 maintenance and service'**.

These screens will only appear if no program is running.

- Select 1 program, and then press the Prog Key. You will then get **'11 run program'**.
- Press the Prog key so that a flashing * appears at the bottom left of the screen.

Note: Parameters on the screen can only be changed when the flashing star appears. To De-activate press program key again.

- Press either of the arrow keys to select between **11 run program and 12 set up new program**.
- Select **11 run program** and press the Prog key to remove the flashing star.
- Press the arrow keys until **load program at Pos 1** appears.
- Press the Prog key until the flashing * appears.
- Press the arrow keys until the desired program number is reached e.g. Pos 3 etc.
- Press the prog key again; the selected program is now loaded into memory.
- Press the arrow keys until **Stopped prog to run** is showing.
- Press the Prog key to run the program. **Running press reset to stop** will show
- To stop the program press the Reset key.

With the program running you can press either of the arrow keys to view various screens while the program is running. For full list see display screen with functions when program is running continuous salt spray test – example astm b117.

These screens will only appear if no program is running.

- After switching on **Prog interrupt resumes in 10 min** will be displayed.
- If you still wish to run this program, let it time out and it will resume after 10 minutes.
- If you want to run a different program, press the reset key twice and **13 stopped prog to run** will be displayed.
- Press the right arrow key until **11 Run program** is displayed.
- Press right arrow key until **12 load program at Pos 1** is displayed.
- Press the Prog key until the flashing * appears.
- Press the arrow keys until your desired program is selected, 1 to 7.
- Press the Prog key to load.
- Press the right arrow key until **13 stopped prog to run** is displayed.
- Press the prog key to run program. **Running press reset to stop** will be displayed.
- To stop the program press the Reset key.

With the program running you can press either of the arrow keys to view various screens while the program is running.

AIR PURGE FUNCTION

If you need to interrupt the test for a few minutes it is advisable that air purge is selected to disperse the fog etc. so that it does not come into your laboratory. A purge can only be selected if a main program is running.

- Press the arrow keys until **Purge Off program running** appears.
- Press the Prog key until the flashing * appears at the bottom left of the screen.
- Press the arrow keys to switch purge on or off. The Purge will run for a time of 5 minutes.
- To switch off prior to the timed limit press the arrow key until Off appears then the Prog key to return to normal running.

If a program is running and there is a power cut. The program is interrupted for 10 minutes, after which the program will continue.

You can override the interrupt to resume the test immediately by pressing the Reset key twice followed by the Prog key once and it will continue on the continuous test you are on.

PROGRAMMING

New programs cannot be entered while a program is running.

To enter a new program follow the instructions below.

Example: Salt Spray ASTM B117

- Press arrow key until **Running reset** to stop appears.
- Press reset to reset the program.
- Press arrow key until **11 Run program** appears.
- Press the Prog key until the flashing * appears.
- Press arrow key until **set up new program** appears.
- Press the Prog key.
- Press the arrow key until **15 Set up segment** appears.
- Press Prog key **151 Set up segment Main 1** will show.
- Press arrow key until **152 Set function** appears.
- Press Prog key until the flashing * appears
- Press arrow key until function required is reached, e.g. Salt Spray.
- Press Prog key to load.
- Press arrow key until **153 Set sub func temp ramp** appears.
- Press Prog key until the flashing * appears
- Press arrow key until function required is reached, e.g. Fixed temp.
- Press Prog key to load
- Press arrow key until **154 Set temp** appears
- Press Prog key until the flashing * appears
- Press arrow key until temperature required is reached, e.g. 35°C
- Press Prog key to load
- Press arrow key until **155 Set water temp** (Humidifier temperature) appears
- Press Prog key until the flashing * appears
- Press arrow key until temperature required is reached, e.g. 48°C
- Press Prog key to load
- Press arrow key until **156 Fog on time continuous** appears
- Press Prog key until the flashing * appears
- Press arrow key until time in minutes required is reached, e.g. 240 mins.
- Press Prog key to load
- Press arrow key **UV Light off** appears **Ignore** this function, as standard cabinets do not have this facility.
- Press arrow key until **Display fog off time** appears
- Press Prog key until the flashing * appears
- Press arrow key until desired function is reached.
- Press Prog key to load
- Press arrow key until **Number of cycles** appears
- Press arrow key until desired no of cycles is reached
- Press Prog key to load
- Press arrow key until **151 Set up segment main 1** appears

To setup more segments this is a simple repeat of the above sequence remembering to change the segments in **151 Set up segment main 1** to 2, 3, etc.

This is done by the standard way whilst in **151 Set up segment main** by ;

- Press Prog key until the flashing * appears
- Press arrow key until **151 Set up segment main 2** appears
- Press Prog key to load
- Then continue the cycle as per above sequence

When you have reached the last segment in your selected program you must end it. This is done from **151 Set up segment main** by:

- Press arrow key until 152 Set function appears.
- Press Prog key until the flashing * appears
- Press arrow key until **End of test** is reached,.
- Press Prog key to load.

You now will need to save the program in a slot 1 to 7.

- Press arrow key until **151 Set up segment main (number of last segment)** appears
- Press the Reset Key **15 Setup seg** will appear
- Press arrow key until **Save program at pos:1** appears
- Press Prog key until the flashing * appears
- Press arrow key until desired position is reached.

Note: Please remember the position of the program as when saved any programs at that position will be overwritten.

- Press Prog key to load **Saving please wait** displayed this will last for 10 seconds
- Press arrow key until **set up new program** appears
- Press Prog key until the flashing * appears
- Press arrow key until **11 Run program** appears
- Press Prog key to load
- Press arrow key until **load program** appears
- Press Prog key until the flashing * appears
- Press arrow key until **load program at pos:1** appears
- Press Prog key to load
- Press arrow key until **13 stopped Prog to run** appears
- Press Prog key to run program

DISPLAY SCREENS WITH FUNCTIONS DISPLAYED WHEN PROGRAM IS RUNNING CONTINUOUS SALT SPRAY TEST – EXAMPLE ASTM B117

- 132 Purge OFF
- Program Running,
- 133 Main Cycles continuous
- 134 Sub Cycle 1 left (ignore this if a sub program has not been entered)
- 135 Segment M1 (main program1) Fog
- fixed temp
- 136 Chamber Temp SP (set point) 35°C
- Tmp 23°C (or what ever the ambient is when the program is started)
- Hum Chamb Temp (Humidifier Tower temperature)
- SP (set point) 47°C
- TMP 23°C (or whatever the ambient is when the program is started)
- 138 Current Function Fog on
- 139 Cycle time continuous (or whatever the fog time that has been set)

PROFILE CONTROLLER TROUBLESHOOTING

To override Start - Press the Reset Key twice then press the Prog Key.
The light will stop flashing.

Display Fault - C+W
Select Function (On screen)

1. Press the Right Arrow Key until **1 Program** is displayed.
2. Press the Prog Key until **11 Set Up New Program** is displayed.
3. Press the Prog Key until **a Flashing Star** is displayed.
4. Press the Right Arrow Key until **11 Run Program** is displayed.
5. Press the Prog Key until **the Flashing Star goes off.**
6. Press the Right Arrow Key until **12 Load Program at Pos:1** is displayed.
7. Press the Prog Key until **the Flashing Star** is displayed.
8. Press the Prog Key again until **the Flashing Star goes off.**
9. Press the Right Arrow Key until **13 Stopped Prog to Run** is displayed.
10. Press the Prog Key again to start the Program.
131 Running Reset to Stop is displayed.

NOTE: If you have a program problem then note what is displayed and then find what is displayed on the process above and follow the instructions given above from that point.

Example: **11 Run Program** is displayed – See No. 4 above and follow the rest of the instructions from there to re-set the program.

CHECK LIST

1. Samples placed without obstructing spray jet nozzle and collection vessels.
2. Cabinet lid seals correctly i.e. sufficient water in trough.
3. Both cabinet temperature controller and humidifier temperature controller has correct set point.
4. Autofil indicator is NOT illuminated i.e. humidifier has not a low water situation.
5. Flowmeter shows a correct flowrate.
6. Air gauge shows a correct air pressure.
7. A Positive fog is generated via the spray jet nozzle.

PROFILE CONTROLLER -AIR PURGE

To put the Air Purge on and off.

1. Press the Left or Right Arrow Key until Program Running 132 Purge Off is displayed.
2. Press the Prog Key once to get a Flashing Star displayed.
3. Press the Left or Right Arrow Key until 132 Purge On Program Stopped is displayed. AIR PURGE STARTS.

To turn Air Purge off.

1. Press the Left or Right Arrow Key until 132 Purge Off Program Running is displayed.
2. Press the Prog Key until the Flashing Star goes off.
AIR PURGE STOPPED.

PLUMBING

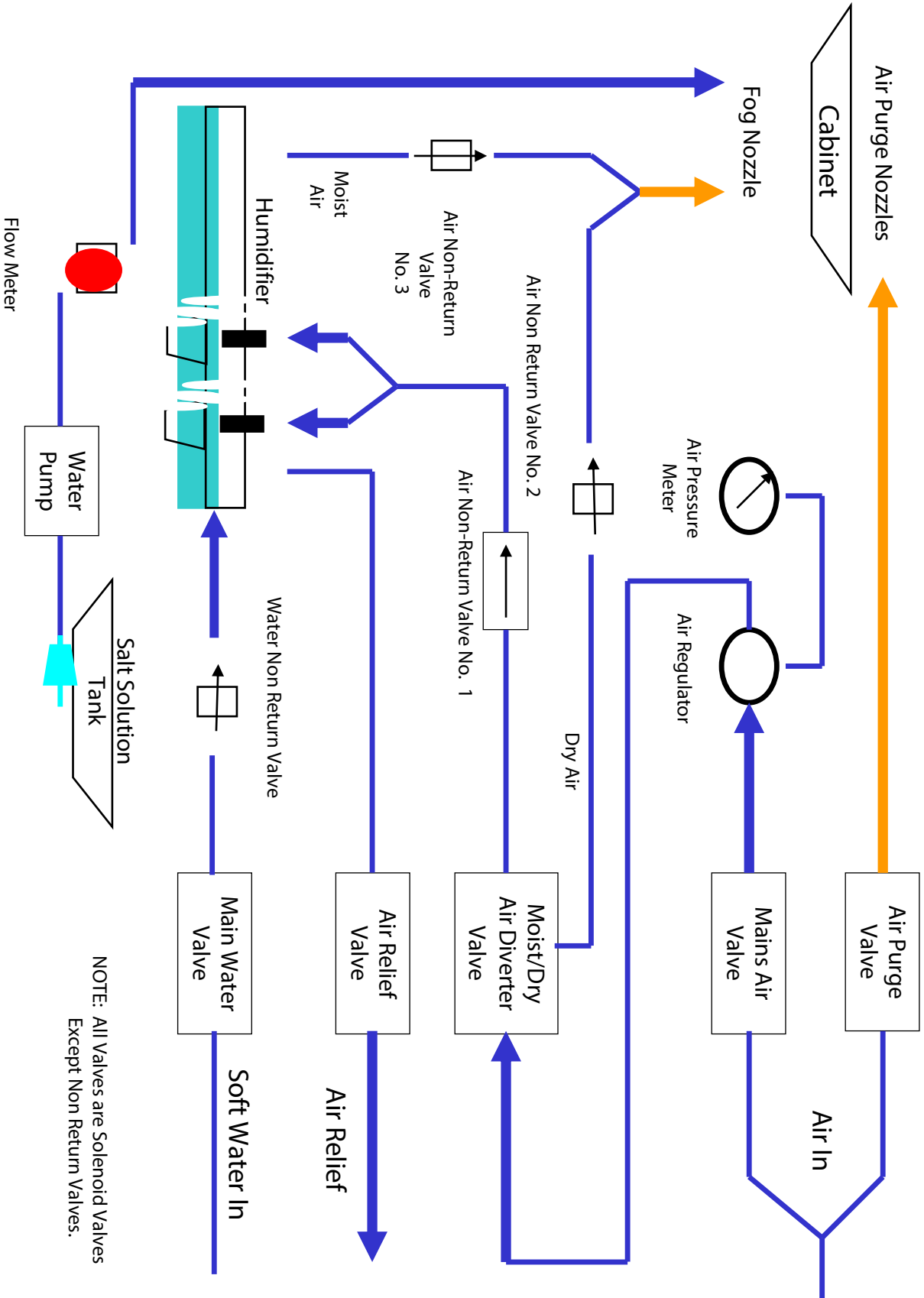

NOTE: All Valves are Solenoid Valves
Except Non Return Valves.

SUMMARY OF ASTM B117

Solution Preparation & Concentration

Concentration of the salt should be 5+/-1%. Water used for preparation should conform to type IV in specification D 1193 (limits of chloride and sodium shall be ignored). Table below gives the details of the maximum level of impurities allowed in sodium chloride used to prepare salt spray solution.

Impurity Description	Allowable Limits
Total impurities	< 3.0%
Halides (Bromides, fluorides & iodides excluding chlorides)	<0.1%
Copper	< 0.3 ppm
Anti Caking Agents	0.0%

PH

PH of the atomised solution should be between 6.5-7.2, which can be achieved in one of the following ways.

1. Heat the water used to prepare salt solution to 35°C or above, dissolve the required quantity of salt and then check and adjust PH if required.
2. When preparing solution adjust the PH to below 6.5.

The PH of the solution prepared in the above 2 ways does not materially change when atomised at 35°C.

Air Supply

There exists a relationship between humidifier temperature and air pressure which is as given below.

NOTE: If the below mentioned table is followed the required amount of fog is generated. The common practice is to keep the temperature of the humidifier between 46 and 49°C.

Air Pressure (PSI)	Temp (°C)
12	46
14	47
16	48
18	49

Condition in the Salt Spray Chamber

The exposure zone of the chamber shall be maintained at 35 +/- 2°C. Temperature shall be recorded twice a day at least 7 hours apart.

Atomisation and quantity of fog

2 fog collectors per atomiser tower need to be placed within the exposure zone one nearest and another furthest from the nozzle in such a way that no drop of solution will be collected from the test specimen or any other source. Funnel to be used should be Ø 100 mm.

Continuity of Exposure

Unless otherwise specified the test shall be continuous for the duration of the entire test period. Continuous operation implies that the chamber be closed and the spray operating continuously except for short daily interruptions necessary to maintain or check the components.

ASTM B117 pH RANGE

6.5 - 7.2

pH to 7.0

pH too low - add Sodium Hydroxide (NaOH)
pH too high - add Hydrochloric Acid (HCl)

A. Salt concentration is tested weekly by titration method.

Titration Method

1. Dilute 5ml of the collected salt solution to 100ml distilled water and mix thoroughly.
 2. Take 10ml of the solution and put into a glass evaporating dish then add 40ml of distilled water and 1 ml of 1 % potassium chromate solution (chloride free).
 3. Titrate with 0.1 N Silver Nitrate solution until the solution gives an appearance of a permanent red colour.
 4. Take reading of amount of 0.1 N Silver Nitrate added to make the colour change to RED.
 5. A solution that requires between 3.4ml and 5.1 ml of 0.1 N Silver Nitrate solution to be added to make the colour change to red will meet the correct concentration requirements of ASTM B117.
- B. Concentration is within range when 3.4 to 5.1 ml of 0.1 Normal Silver Nitrate (**0.1 N AgNO₃**) is used during a titration test.
If Salt Concentration is too low - increase salt next mix.
If Salt Concentration is too high - decrease salt next mix.

5% Salt Solution should be 5 grams salt per 95ml H₂O

ADJUSTING THE pH OF SALT SOLUTION

pH below 6.5

- a) Add approximately 100 grams Sodium Hydroxide to 1 litre of distilled water and stir carefully until dissolved.
- b) Add a little of the solution to the salt solution reservoir and stir thoroughly.
- c) Check pH value, allowing the pH metre 30-40 seconds to settle.
- d) Repeat b) and c) until pH is within specification.

pH above 7.2

- a) Add 5cc Hydrochloric Acid to 1 litre of water and stir carefully.
- b) Add a little of solution to the reservoir and stir thoroughly.
- c) Check pH value allowing pH meter 30-40 seconds to settle.
- d) Repeat b) and c) until pH is within specification.

Care

Read the instructions on the chemical containers before use as these chemicals are highly corrosive.

Avoid skin contact. If contact is made, wash area thoroughly in water and seek medical advice if required.

CHECK LIST

1. Samples placed without obstructing spray jet nozzle and collection vessels.
2. Cabinet lid seals correctly i.e. sufficient water in trough.
3. Both cabinet temperature controller and humidifier temperature controller has correct set point.
4. Autofill indicator is NOT illuminated i.e. humidifier has not a low water situation.
5. Flowmeter shows a correct flowrate.
6. Air gauge shows a correct air pressure.
7. A Positive fog is generated via the spray jet nozzle.

HOW TO CHANGE THE TUBING ON A PERISTALTIC PUMP

Instructions

1. Twist the pump cover 30° anti-clockwise until it unlocks. See Fig. 2
2. Remove pump cover from grey pump housing. See Fig. 3
3. Unclip grey clips from bottom of inside of pump cover. See Fig. 4
4. Remove tube and grey locking clips from pump cover. See Fig. 5
5. Remove grey locking clips from tubing. See Fig. 5
6. Unscrew blue locking caps on pump panel to allow old tube to be pulled off. Remove old tubing and discard. Clean off old dust or debris from pump head. See Fig. 6
7. Cut new length of silicone tube at least 600mm long. See Fig. 7
8. Place flat blade screwdriver in location position in centre white pump rotation drum and turn slowly clockwise to feed the new tube into the channel between the pump rotation drum and the pump cover. See Fig. 7
9. Attach grey locking clip onto tube on both sides and push back into position on pump cover. Ensure the correct fitment of the locking clips when attaching to the pump head, as incorrect fitment will damage the pump and invalidate any warranty. See Fig. 7 / 8
10. Put blue locking caps back onto the tube and reconnect the tube onto the blue fittings on the pump panel and tighten. See Fig. 8, 9 & 10
11. Reposition pump cover locating the centre onto the white plastic drive shaft and lock cover by turning clockwise onto the grey housing. See Fig. 11 & 12.
12. Finished! See Fig. 1

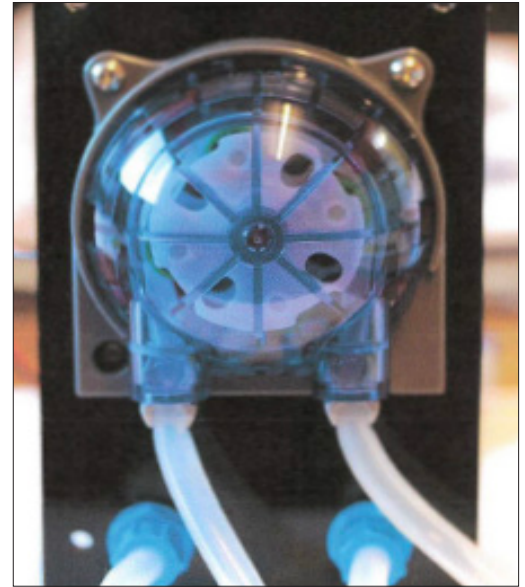

Fig. 1



Fig. 2

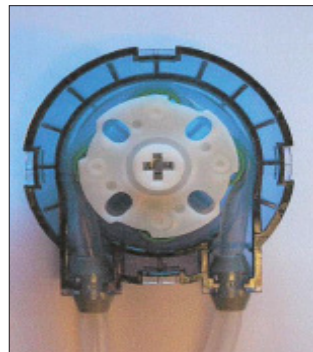

Fig. 3

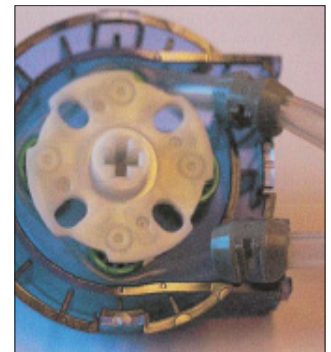

Fig. 4



Fig. 5



Fig. 6

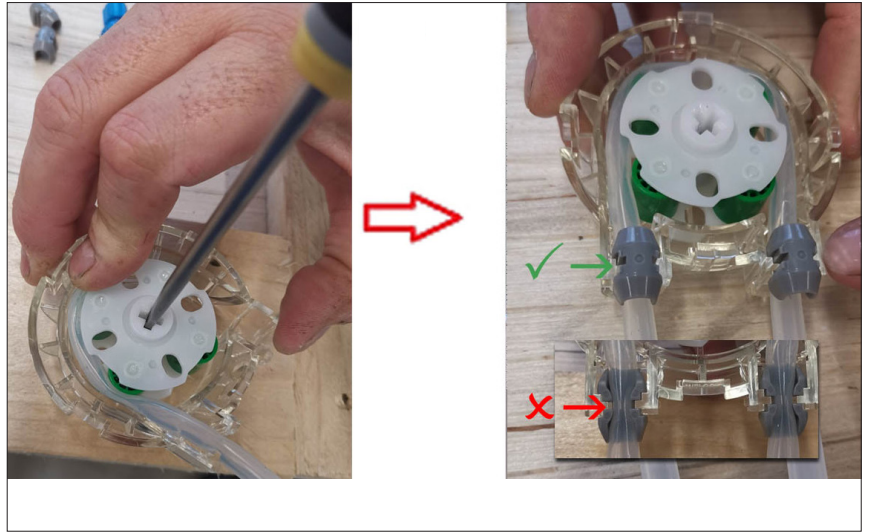

Fig. 7

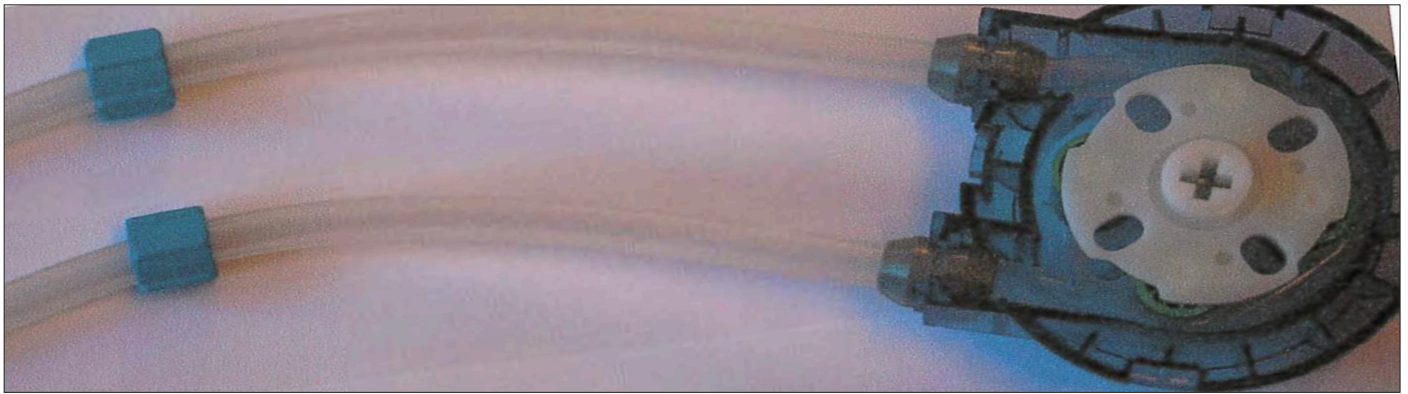

Fig. 8

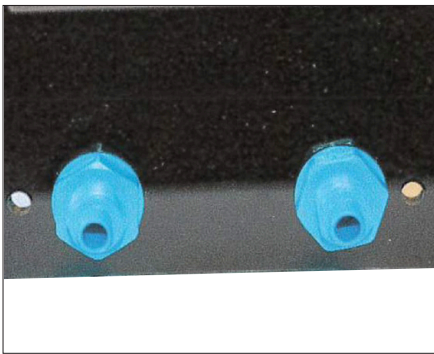

Fig. 9

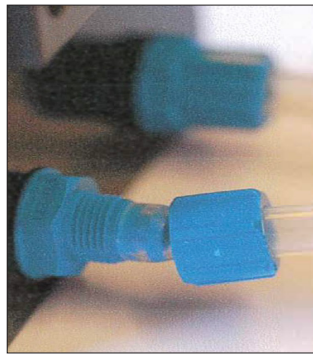

Fig. 10

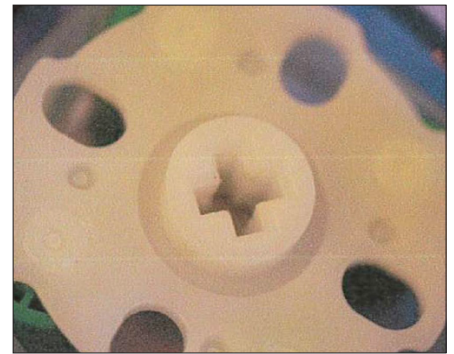

Fig. 11

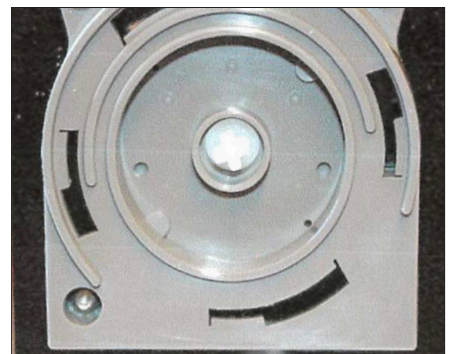

Fig. 12

ESSENTIAL CABINET MAINTENANCE

1. Cabinet Roof Seal

During testing the water from the water seal evaporates. It is naturally replaced by droplets running down the apex roof into the water trough. After prolonged testing it is recommended that the water trough is emptied and sterilised using a weak solution of household bleach and replenished with fresh water.

2. Peristaltic Pump

The tube on the Peristaltic Pump should be replaced every 10 to 12 weeks of use, as the wall of the tube is eroded due to the action of the pump rollers. This also causes the tube structure to collapse, which restricts the salt solution flow. Additionally the tube could split, which will result in the salt solution being pumped over the pump itself and the also onto the floor of your laboratory.

IMPORTANT NOTE:

It is vital that silicone tube is replaced every 10 to 12 weeks of use. This will prevent the tube from splitting and leaking.

ADDITIONALLY:

The correct size of tube should be used on the pump otherwise the required flow rates will not be achieved, and also damage to the pump rollers could occur.

Use of the incorrect tube will also damage the pump motor, Resulting in motor failure.

Use of the wrong peristaltic pump tube invalidates the guarantee on the complete pump unit.

3. Reservoir Filters

At least once every 3 months the disposable salt solution filter in the salt solution reservoir should be replaced. It may be necessary to replace this filter more frequently depending on the quality of water used on making up the salt solution. If you find Brown Algae in the filters, the reservoir should be cleaned using a weak solution of domestic bleach.

4. Spray Nozzle

It is recommended at six monthly intervals that the spray jet nozzle, "Fluid Cap", is removed from the spray jet nozzle assembly and soaked in a container of clean hot water (50°C max).

It is not considered necessary to replace the spray jet nozzle gasket every time the fluid cap is removed but recommended it is replaced annually. It is policy for our service engineers to exercise the above procedure should you employ our service and calibration contract offered on an annual basis, 12 months after the delivery of your cabinet.

FAILURE TO FOLLOW THE ABOVE INVALIDATES THE WARRANTY

September 2019

HEALTH AND SAFETY AT WORK ACT – LEGIONELLA REF: ACoP LB

As you are probably aware there are some 34 different species of the bacteria known to man and they can be found in rivers, lakes, streams, mud and soil.

The bacterium Legionella multiplies only when conditions are at a suitable level and these are:

1. When water temperatures are between 20° C and 45° C with 37° C being the optimum laboratory temperature.
2. When water is contaminated with sediment, sludge, organic matter and algae. Algae are a good source of nutrients and when a bio film is formed it provides a stable habitat for the multiplication of bacterium Legionella.
(A bio film is a layer of micro organisms contained in a matrix which forms slime on surfaces in contact with water).

Infection is caused by inhaling airborne droplets of particles containing viable Legionella bacteria.

Facts and Conditions Concerning Salt Spray Cabinets and the Growth of Legionella Bacteria

Regarding Salt Spray Cabinets, the conditions within the unit are such that the chances of infection are very low.

1. Legionella bacteria will not grow and multiply in a 5% solution of sodium chloride.
2. Salt Spray Cabinet and Humidification Tower - this should be maintained at 47°C, a temperature outside the range which favours growth of the bacterium.

Facts and Conditions Concerning Humidity Cabinets and the Growth of Legionella Bacteria

Regarding Humidity Cabinets, the conditions within the unit are such that the chances of infection are very low.

1. The water bath in the cabinet is maintained at a level of 65° C and this temperature is considered suitable for sterilisation and one at which Legionella bacteria will not reproduce.
2. The air temperature is maintained by the evaporation of water in the form of humidity and not in a spray of droplet form; consequently the chance of transmission of Legionella bacteria by this condition is very low indeed.

Procedures to Prevent the Growth of Legionella Bacteria

1. We recommend most strongly that the Humidity Cabinet and Salt Spray Cabinet undergo regular chlorination with a solution of sodium or calcium hypochlorite 100ml/litre of water.
2. The Salt Spray Cabinet is always opened after a five minute air purge when the salt fog has been removed from the chamber.
3. The Salt Spray Cabinet should never be opened when the spray is being produced.
4. The water trap on both the Humidity Cabinet and Salt Spray Cabinet are kept free of sediment, sludge, scale, organic material and algae by regular chlorination as mentioned in section 1, at intervals of not less than once a month.
5. The salt solution reservoir should be cleaned by chlorination as mentioned in section 1, each time the contents have been used, this is essential to prevent a bio film developing on the walls of the reservoir as algal slime.
6. The salt solution filter should be changed every six to ten weeks to prevent the build up of bacteria and algae colonies.
7. A solution of sodium or calcium hypochlorite (100ml per litre of water) should be pumped through the salt delivery system to prevent the build up of algae and bacteria in areas where stagnation could occur. This should be done at the same time as section 5.

Conclusion

The bacterium Legionella is a commonly occurring organism which is found naturally throughout the world, consequently as an airborne life form it is difficult to eradicate totally and permanently from any environment. With these facts, we as a company can not guarantee that our cabinets will not be susceptible to Legionella bacterium however if our maintenance procedures and operating instructions are followed the chances of infection are greatly reduced.

The company does not accept any liability to third parties using chambers it manufactures in connection to contracting the bacterium Legionella.

On behalf of the company

Remco Wever
Managing Director

TROUBLE SHOOTING

Below are listed several helpful diagnosis hints, should you experience any errors that may interfere with your testing.

No Salt Fog

1. Check that you have sufficient salt solution.
2. Check that the salt solution filter is not blocked.
3. Check that there is no split in the pump tubing.
4. Check that the spray jet nozzle is not blocked.

Incorrect Salt Solution Fallout Collection Rates

1. Check that the correct flowrate is being pumped.
2. Check that the spray jet nozzle air pressure is set correctly.
3. Is the spray jet nozzle positioned central.
4. Is the spray jet nozzle blocked or partially blocked.
5. If the salt solution fallout rates are evenly distributed but either high or low in collection adjust the pump speed by increasing or decreasing accordingly.
6. If the salt solution collection rates are satisfactory but the distribution uneven.
 - a) High collection rates in the centre of the test chamber and low collection rates on the outer edges (increase spray jet nozzle air pressure).
 - b) Low collection rates in the centre of the test chamber and high collection rates on the outer edges (decrease spray jet nozzle air pressure).

No Air Pressure Gauge Reading

1. Check to see if Air Purge is selected.
2. Is a continuous air supply connected to the cabinet, (including evenings and weekends).

No Humidifier Temperature Display

1. Check to see if Air Purge is selected.
2. Check to see if the Humidifier tower is undertaking an autofil function (Autofil indicator illuminated).
3. Is a continuous water supply connected to the cabinet with a 2-4 Bar pressure.

DISCLAIMER

The right of technical modifications is reserved.

The information given in this manual is not intended to be exhaustive and any person using the product for any purpose other than that specifically recommended in this manual without first obtaining written confirmation from us as to the suitability of the product for the intended purpose does so at his own risk. Whilst we endeavor to ensure that all advice we give about the product (whether in this manual or otherwise) is correct we have no control over either the quality or condition of the product or the many factors affecting the use and application of the product. Therefore, unless we specifically agree in writing to do so, we do not accept any liability whatsoever or howsoever arising for the performance of the product or for any loss or damage (other than death or personal injury resulting from our negligence) arising out of the use of the product. The information contained in this manual is liable to modification from time to time in the light of experience and our policy of continuous product development.



C&W Specialist Equipment
Unit 2, Burnside Court
Brunel Road
Leominster
Herefordshire
HR6 0LX United Kingdom

Phone: +44 (0) 2039 3635 65
E-mail: sales.service@cw-spec.com

www.cw-spec.com