

Cyclic Corrosion Test Cabinet

SF/100/CCT - CW1401, SF/200/CCT - CW1402, SF/450/CCT - CW1404,
SF/750/CCT - CW1407, SF/1000/CCT - CW1410, SF/2000/CCT - CW1420

Operating Instructions (V2.0 1019)



IMPORTANT! Before taking this instrument
in use we strongly advise you to read this
manual carefully.

GUARANTEE

C&W Specialist Equipment Limited (hereinafter called C&W) guarantee the cabinet supplied for a period of one year from the date of delivery to the customers place of work subject to the below mentioned conditions and excluding the items listed. If within the said period any part of the cabinet is found to be defective, C&W will (subject to the conditions and excluded items) exchange or repair such parts free of charge. All labour, transport and material costs are covered by this guarantee.

This guarantee is to be additional to and does not take away any of the purchaser's rights under the Sale of Goods Act 1979. Neither does this guarantee supersede any guarantee given by the manufacturers whose services will be employed where appropriate.

Conditions of Guarantee

1. The cabinet has not been tampered with or repaired by anyone other than an employee or agent of C&W, unless under direct instructions from C&W.
2. The cabinet has been installed correctly as per the instructions of C&W.
3. The cabinet has not been subject to misuse, or to willful or accidental damage (including damage caused by fire or lightning).
4. The cabinet has been used solely for the purpose for which it was manufactured and kept in and operated to the conditions specified by C&W.
5. The guarantee excludes parts that have a limited life span and components that are non mechanical or electrical that fail due to third party damage.
 - Indicator Lamps
 - Light Bulbs
 - Fuses
 - Salt Solution Filters
 - Peristaltic Pump Tubing
 - Salt Fog Atomiser (fluid cap only)

On behalf of the company

Remco Wever
Managing Director

CONTENT

1. CYCLIC CORROSION TEST CHAMBERS	4
Controlled temperature changes	4
Constant temperature drying	5
Forced air drying	5
Constant temperature high humidity	5
Cyclic temperature high humidity	5
Combined sequence testing	5
Continuous testing	5
Intermittent testing	6
2. INSTALLATION	7
Mains Electricity	7
Compressed Air Supply	7
Water Supply	7
Drains/Vent	9
Cabinet Positioning	10
3. TECHNICAL INFORMATION	11
4. CONSTRUCTION	11
5. HEATING SYSTEM	12
Sample chamber	12
Sat Rh generation	12
Air humidifier	12
Temperature control, Sample chamber	12
Air humidifier control	12
Cabinet protection	12
6. TABLE OF SALT SPRAY STANDARDS - ALL MODELS	13
7. PROFILE CONTROLLER	14
To run a program	14
Air Purge Function	15
Sample program CCT-VH-E	15
CCT Program	19
8. CHECK LIST	22
9. SCHEDULED MAINTENANCE	23
10. TROUBLE SHOOTING	26
No Humidity	26
No Heat	26
11. GAS SPRINGS - SAFETY REQUIREMENTS	27
Installation instructions	27

1. CYCLIC CORROSION TEST CHAMBERS

Models SF/2000/CCT, SF/1000/CCT, SF/750/CCT, SF/450/CCT, SF/200/CCT, SF/100/CCT

This range of advanced controlled environment test systems has been developed to enable the corrosion engineer to subject his samples to the following range of conditions quickly, accurately and conveniently.

1. CONTROLLED TEMPERATURE CHANGES.
2. SALT FOG ENVIRONMENT.
3. CONSTANT TEMPERATURE DRYING.
4. FORCED AIR DRYING.
5. CONSTANT TEMPERATURE HIGH HUMIDITY.
6. CYCLIC TEMPERATURE HIGH HUMIDITY.

These facilities have been incorporated into the system with a user configurable programmer/controller interfaced via a solid state decoder to the various relays and actuators required.

CONTROLLED TEMPERATURE CHANGES

Controlled temperature changes are achieved by programming the temperature to be reached against the rate of change of temperature so that temp/time is a straight line function of variable slope. In addition to just changing temperature other functions can be introduced at the same time, these include washing waste products from the humidity generator after a salt fog spray. The Programmer/Controller used for control of the temperature calls for either heating or cooling dependent upon the slope of the time/temp gradient. The cooling can be switched either on or off via the controller to increase the slope of the temperature gradient i.e. ramp rate.

SALT FOG ENVIRONMENT

A specially designed Lucite atomiser jet mounted centrally in the lower half of the sample chamber generates a fine salt mist with the atomised product about 100 microns diameter by the introduction of:

- a) **Air:** Dependant upon the standard to which the machine is required to operate the air supply can be either humidified or dry.

Humidified Air: Compressed, oil free and filtered air is introduced via an air regulator and pressure gauge to a humidifier system where it is heated to a preset temperature and moistened prior to its introduction to the atomiser jet.

Dry Air: Is supplied to the atomiser jet via an air regulator and pressure gauge after being filtered etc. It is not treated in any other way to alter its temperature or moisture content.

- b) **Salt Solution:** The specified salt solution is contained in an external reservoir and is introduced to the jet via an inline filter, a variable speed pump and flowmeter. Accurate control of the flow rate and air pressure enable the operator to quickly and repeatedly adjust the fall out per unit area of the test chamber to that required by the various testing standards.

CONSTANT TEMPERATURE DRYING

Can either take place after a salt fog cycle or a humidity cycle is programmed into the sequence of events predetermined by the test conditions. The temperature in the test chamber is raised by an amount that reduces the humidity of the test chamber to acceptable levels and maintained for the period of time required to dry the surface of the samples THOROUGHLY.

FORCED AIR DRYING

More complete drying can be obtained by the introduction of a quantity of circulating air into the test chamber and also keeping the set temperature at an elevated level.

CONSTANT TEMPERATURE HIGH HUMIDITY

This event normally requires temperatures greater than 35°C but not often higher than 48°C. The test chamber can be set anywhere between these temperatures. Water is introduced into humidity generators and heated by the computer and its associated equipment to maintain the test chamber temperature. The generated humidity level is generally between 93 and 98%, adequate for all specifications.

CYCLIC TEMPERATURE HIGH HUMIDITY

In general this test requires temperature changes between 42°C and 48°C at time intervals of 30 minutes. These temperature changes can be programmed into the controller by the use of a sub program for a number of cycles as required by the various testing specifications. At the end of this sequence the system can revert back to any other part of the combined testing cycle.

COMBINED SEQUENCE TESTING

These events can be combined in a large number of ways to make up a complete sequence of tests. Typical testing cycles contain at least three of the above parameters at different temperatures e.g. salt fog at 35°C, drying at 60°C and humidity at 42°C with time intervals of 4 hours, 2 hours and 2 hours. These variations can be modified at will by entering programs into the memory contained in the programmer/controller.

CONTINUOUS TESTING

The system can easily be programmed to carry out:-

1. Salt Fog Spraying (continuous or intermittent)
2. Constant Temperature High Humidity.
3. Cyclic Temperature High Humidity.

Programming these events is quite simple and they can be called up from the controller memory at any time after a program reset has been displayed. An adequate time period can be programmed into the continuous test.

INTERMITTENT TESTING

Again the system can be programmed to carry out intermittent salt fog and drying tests. The Mebon Prohesion test is one that comes to mind as an example of this type of sequence. It is quite a simple matter to program humidity testing with a drying cycle either at elevated temperature or at ambient temperature over a number of sequences.

THE COMPLEXITY OF THE TESTING SEQUENCE IS OVERCOME BY THE SIMPLICITY OF PROGRAMMING THE SYSTEM

2. INSTALLATION

Services Required:	1)	Mains Electricity
	2)	Compressed Air Supply
	3)	Water Supply

MAINS ELECTRICITY

2000 litre capacity chamber

SF/2000/CCT			
3 Phase Power Supply	380-415V	2Kw/16 Amp per Phase	6Kw (max load)

1000 litre capacity chamber

SF/1000/CCT			
25 Amp Power Supply	220-240V	50/60Hz	5Kw (max load)

450 litre capacity chamber

SF/450/CCT			
16 Amp Power Supply	220-240V	50/60Hz	3.2Kw (max load)

200 litre capacity chamber

SF/200/CCT			
13 Amp Power Supply	220-240V	50/60Hz	2.2Kw (max load)

100 litre capacity chamber

SF/100/CCT			
13 Amp Power Supply	220-240V	50/60Hz	2.2Kw (max load)

COMPRESSED AIR SUPPLY

A clean, oil free and filtered air supply is required.

When using mains air, a wall mounted air regulator should be used to reduce the air pressure entering the test chamber to 2-4 Bar (30 - 60 psi).

WATER SUPPLY

A clean water supply should be connected to the test chamber.

In areas known to have a hard water supply, it is recommended to install an inline de-ioniser unit to prevent a build-up of calcium deposits on the operative solenoid valve seats and the humidity generator heating elements.

The pressure of the water supply should be regulated to between 2 - 4 Bar (20- 60 psi).

Note: It is important to note that minimum water pressure should be no less than 2.0 Bar (30 psi).

METHODS FOR DRAINAGE

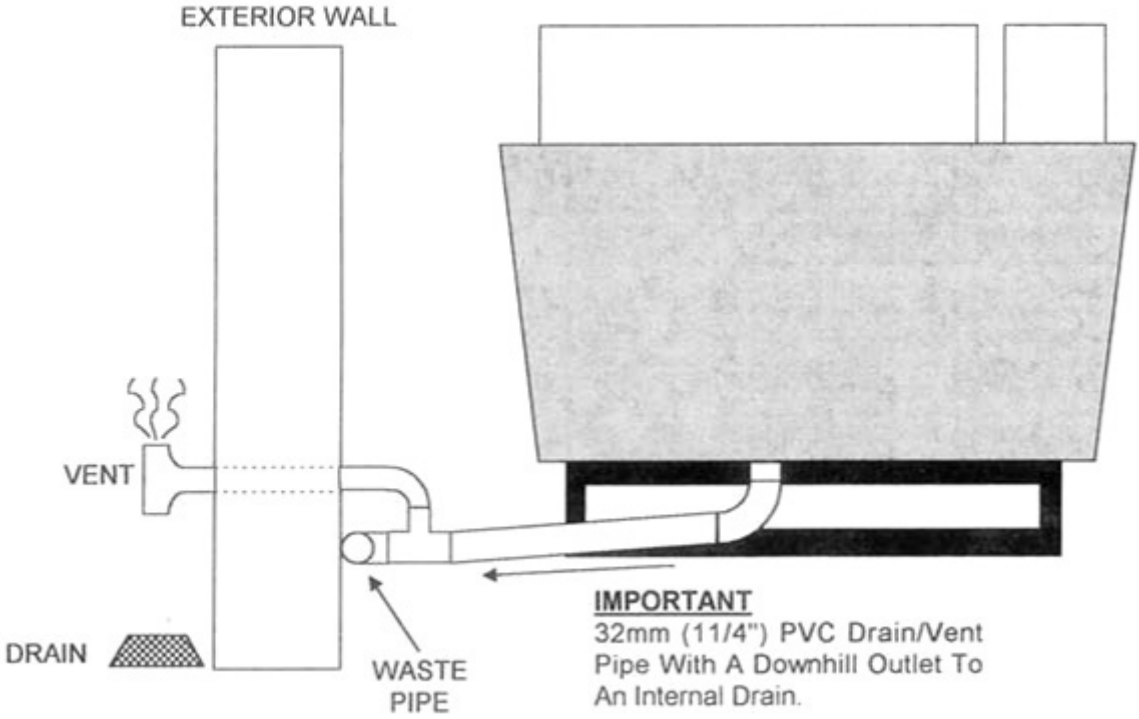
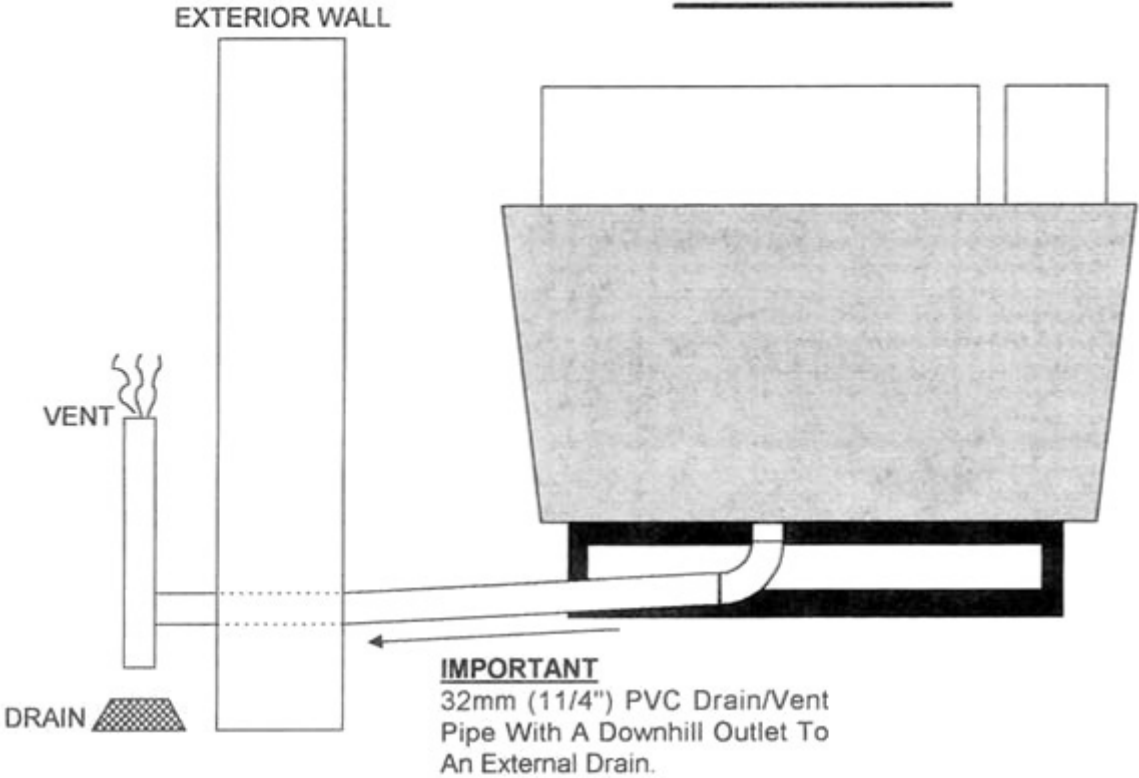

METHODS FOR DRAINAGE

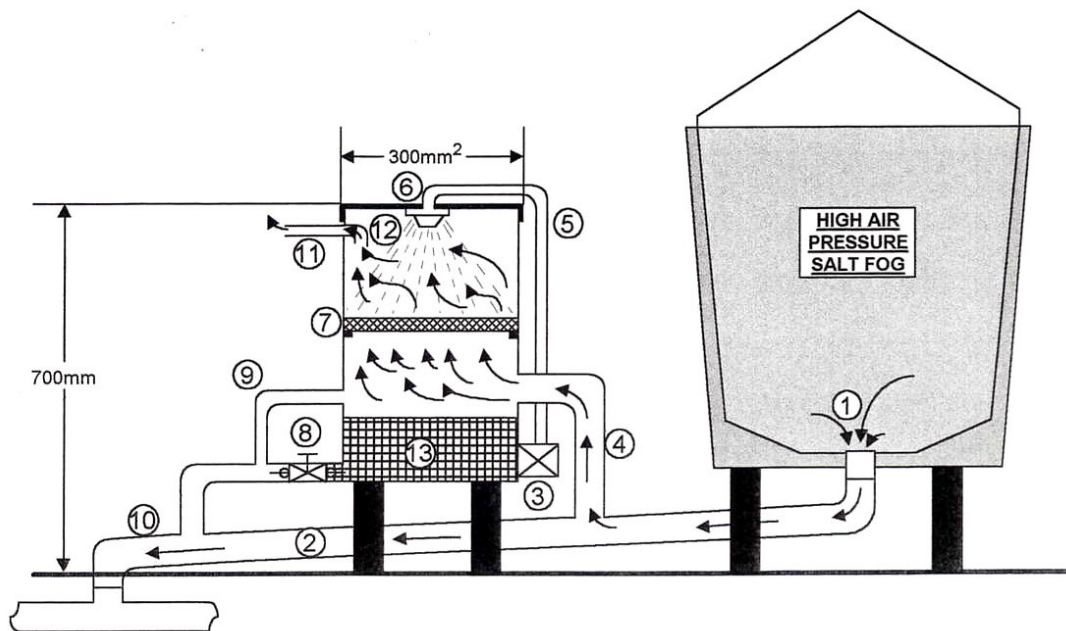
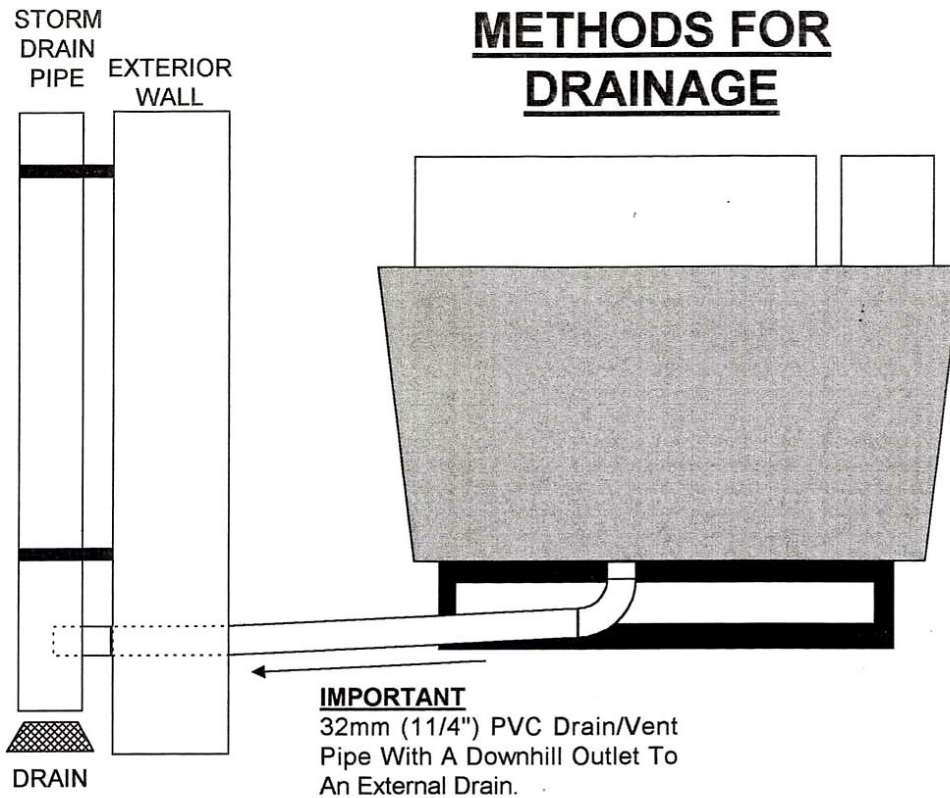

- | | | |
|---|-----------------|---------------------|
| 1 Combined Liquid Drain And Air Escape. | 6 Spray Nozzle. | 11 Clean Air Vent. |
| 2 Drain To Waste. | 7 Filter Bed. | 12 Baffle. |
| 3 Electric Pump. | 8 Drain Tap. | 13 Water Reservoir. |
| 4 Vent Breather Pipe. | 9 Overflow. | |
| 5 Water Spray Line | 10 Drain | |

DRAINS/VENT

An 1 1/4" p.v.c. pipe is used to drain away the used Salt Solutions from the test chamber. It is important that this 1 1/4" p.v.c. pipe follows a continuous downhill slope to your foul water drain system.

You may wish to insert a U bend in the pipe to eliminate stray odours returning to the test chamber.

Essential

It is essential that a T section is inserted into the 1¼" p.v.c. pipe within 1 metre from the test chamber with a rising pipe "**VENT**" being incorporated and routed to an exterior location. This in turn allows any build up of pressure inside the test chamber to vent to atmosphere.

A second drain from the test chamber drains the water from the humidity generator water baths. This should be connected to your 1¼" p.v.c. pipe and allowed to run to your foul water drain system.

CABINET POSITIONING

The test chamber and control module should be placed in a convenient position within 2 m to all services (Power, Air, Water and Drain) on a level surface and away from any external heating influence i.e. radiators, heaters, and direct sunlight.

The power input cables should be connected into the "Power In" box on the bottom left hand panel of the control module and connected to terminals 1, 2 and 3.

The air supply is connected via a hose fitting on the rear right hand side of the test chamber, labeled "AIR INLET".

The water supply is connected via a hose fitting on the rear left hand side of the test chamber, labeled "WATER INLET".

The 1¼" p.v.c. drain/vent pipe exhausts at the rear lower region of the test chamber.

3. TECHNICAL INFORMATION

TEST CHAMBER	100 Litre	200 Litre	450 Litre	750 Litre	1000 Litre	2000 Litre
External Dimensions						
Length	1000 mm	1030 mm	1370 mm	1740 mm	1960 mm	2400 mm
Width	600 mm	700 mm	930 mm	1230 mm	1335 mm	1200 mm
Height	645mm	1050 mm	1130 mm	1365 mm	1410 mm	1645 mm
Internal Dimensions						
Length	600 mm	610 mm	825 mm	1120 mm	1465 mm	2000 mm
Width	450 mm	510 mm	635 mm	870 mm	1040 mm	1000 mm
Height without lid	375 mm	455 mm	620 mm	780 mm	720 mm	850 mm
Height with lid no apex	565 mm	660 mm	875 mm	1070 mm	1065 mm	1175 mm
Panel Capacity						
150mm x 100mm	72	80	132	210	344	516

4. CONSTRUCTION

The outer cabinet is molded from glass reinforced plastic using high temperature polyester resin, colour pale blue. This houses the air humidifier, variable flow pump and the rate of flowmeter. The whole being mounted on load bearing supports for floor mounting.

The internal chamber is molded from self coloured glass reinforced plastic with strengthened sides and floor to carry the sample holders or special fixtures. The floor is capable of carrying considerable weight and will support loads of up to 60 Kilo when distributed over the total area.

The roof is of welded construction from insulated polyurethane sheet with an angle of approximately 115 degrees. Gas springs and hinges make for easy opening and closing. When closed the lid sits in a water trap that is self generating when salt fog or humidity cycles are operated. This water seal prevents the leakage of corrosive material from the test chamber and it holds sufficient liquid to maintain the seal on other cycles of the system program.

5. HEATING SYSTEM

SAMPLE CHAMBER

Panel heaters are mounted onto the outside of the test chamber and insulated from the outer cabinet by low thermal conductive material. This makes for an efficient form of heating with low loss to the outer cabinet wall.

SAT RH GENERATION

In the event of a humidity sequence being called for by the computer then the humidity generator is filled with water. Heaters in the water bath raise the temperature of the sample chamber and keep either a constant or cyclic temperature at humidity levels of between 90% and 98%.

AIR HUMIDIFIER

An immersion heater enclosed in the humidifier tower controlled from a digital temperature controller and on a salt fog cycle holds the humidifier to the preset temperature called for in the testing requirements. This heater can also be controlled from a switch on the main control panel should cool humidified air be called for.

TEMPERATURE CONTROL, SAMPLE CHAMBER

Close control of the sample chamber temperature is obtained from a programmer/controller. This controller manages the wall heaters and the heaters in the humidity generator, it looks after the rate of change in temperature ramps and the time dwell at each test in the cycle. The outputs from the controller are used to control the ancillary functions associated with the above main functions. A built in protection system prevents the humidity generator heating from being applied in the event of little or no water in the generator reservoirs but maintains the cabinet temperature by use of the side wall heating.

AIR HUMIDIFIER CONTROL

The temperature of the air humidifier system is derived from a sensor mounted in the immersion heater thermostat pocket and connected to a simple accurate digital readout control system. The system controls the water temperature to within $\pm 1^{\circ}\text{C}$ adequate for the requirements of this part of the system. Protection of the humidifier in the event of low or no water is as follows. Air is diverted from the system and the immersion heater is switched off. When low water is detected, an air relief valve opens and water is let into the container until it is topped up, air and heating are then restored and humidified air is again used to create the salt fog spray.

CABINET PROTECTION

In the event of any electrical parts failing, protection of the cabinet is by a series of fuses or over current cutouts, these protect the heaters, the control equipment, the air humidifier system and the cooling fans. The controllers are open circuit sensor protected, the immersion heaters in the humidifier generators are protected by a low water float switch and by thermal fuses. Over temperature protection of the sample chamber is by an alarm signal releasing a relay in series with the heating conductors and thus switching off the heating until the alarm is released either by the operator or when the fault conditions have cleared.

6. TABLE OF SALT SPRAY STANDARDS - ALL MODELS

Our cabinets meet the requirements for testing according to the following standards:

Standard	Spray Cycle	Atomiser Air	Cabinet Temp	Fall out (ml) per <u>80cm²/hr</u>
BRITISH				
BS 2011:Part 2.1Ka	Continuous	-	35°C	0.5 to 3.0
BS 3900 F4	Continuous	-	20°C	-
BS 3900 F12 (ISO 7253 1984)	Continuous	95 - 98% RH	35°C	0.1 to 2.0
BS 5466 Part 1(ISO 3768 1976) Part 2(ISO 3769 1976) Part 3(ISO 3770 1976)	Continuous	95 - 98% RH	35°C	-
BS AU148 Part 2	Continuous	-	+25°C	1.0 to 2.0
DEF 133	Continuous	-	+35°C	-
DEF 1053 Method 24	Continuous	-	35°C	-
DEF 1053 Method 36	Intermittent 10 mins/hour	-	-	-
AMERICAN				
ASTM B117	Continuous	95 - 98% RH	35°C	1.0 to 2.0
ASTM B287	Continuous	95 - 98% RH	35°C	0.75 to 2.0
ASTM B368 CASS	Continuous	95 - 98% RH	49°C	1.0 to 2.0
MIL STD 202E	Continuous	95 - 98% RH	35°C	0.5 to 3.0
MIL STD 810C	Continuous	-	35°C	0.5 to 3.0
GERMAN				
DIN 50.907	Intermittent 5 mins/hour	-	20°C	-
SS DIN 50.021	Continuous	95 - 98% RH	35°C	-
ESS DIN 50.021	Continuous	95 - 98% RH	35°C	1.5
CASS DIN 50.021	Continuous	95 - 98% RH	50°C	1.5
DIN 40.046	Continuous	-	35°C	0.5 to 3.0
VG 95210	Continuous	-	35°C	0.5 to 3.0
VG 95332	Continous	-	35°C	2.0
FRENCH				
CCT U01 01A	Continuous	-	35°C	0.5 to 3.0
PN-X 14-002	Continuous	84 - 90% RH	35°C	0.5 to 3.0

Mebon Prohesion® Test - Cabinet Model No. SF/MP4 will carry out all the above standards and the Mebon Prohesion Test.

©Prohesion is the Registered Trade Mark of Mebon Paints Plc

7. PROFILE CONTROLLER

The controller can save 7 programs with a maximum of 20 segments per program.

TO RUN A PROGRAM

Before a program can be run one must be selected between 1 and 7 and loaded into the memory.

- After switching on the machine C+W select function appears in the controller window.
- Press either the left or right arrow keys and you will get '**1 program**' or '**2 maintenance and service**'.

These screens will only appear if no program is running.

- Select **1 program**, and then press the Prog Key. You will then get '**11 run program**'.
- Press the Prog key so that a flashing * appears at the bottom left of the screen.

Note: Parameters on the screen can only be changed when the flashing star appears. To De-activate press program key again.

- Press either of the arrow keys to select between **11 run program** and **12 set up new program**.
- Select **11 run program** and press the Prog key to remove the flashing star.
- Press the arrow keys until **load program at Pos 1** appears.
- Press the Prog key until the flashing * appears.
- Press the arrow keys until the desired program number is reached e.g. Pos 3 etc.
- Press the prog key again; the selected program is now loaded into memory.
- Press the arrow keys until **Stopped prog to run** is showing.
- Press the Prog key to run the program. **Running press reset to stop** will show
- To stop the program press the Reset key.

With the program running you can press either of the arrow keys to view various screens while the program is running.

These screens will only appear if no program is running.

- After switching on **Prog interrupt resumes in 10 min** will be displayed.
- If you still wish to run this program, let it time out and it will resume after 10 minutes.
- If you want to run a different program, press the reset key twice and **13 stopped prog to run** will be displayed.
- Press the right arrow key until **11 Run program** is displayed.
- Press right arrow key until **12 load program at Pos 1** is displayed.
- Press the Prog key until the flashing * appears.

- Press the arrow keys until your desired program is selected, 1 to 7.
- Press the Prog key to load.
- Press the right arrow key until **13 stopped prog to run** is displayed.
- Press the prog key to run program. **Running press reset to stop** will be displayed.
- To stop the program press the Reset key.

With the program running you can press either of the arrow keys to view various screens while the program is running.

AIR PURGE FUNCTION

Air Purge can be programmed to automatically operate as part of cyclic program or there is a manual purge button on the front console which enables users to purge the cabinet before opening the lid.

SAMPLE PROGRAM CCT-VH-E

PROGRAM 1 – FORD BI 123-03

NOTE: PROGRAM 1 MUST BE RESET BEFORE YOU CAN EDIT IT.

1. Press the Page Key until you come to "Program Edit" page.
2. Press the Up Key to select Program 1.
3. Press the Scroll Key to select "Cycles" and set to "Continuous".
4. Press the Scroll Key to select "Segment Type".
5. Press the Up Key to select "Time".
6. Press the Scroll Key to select "Ch1 Target sp".
7. Press the Up Key and set to 23°C.
8. Press the Scroll Key to select "Ch2 Target sp".
9. Press the Up Key and set to 50%.
10. Press the Scroll Key to select "Duration".
11. Press the Up Key and set to "00.1" (1 minute).
12. Press the Scroll Key to select "Events".
13. Press the Scroll Key until you reach the seventh box.
Press the Up Key to select Event 5 and 1 and fill the box.
14. Press the Scroll Key to select "Segment Type". This is Segment 2.
15. Press the Up Key and select "Time".
16. Press the Scroll Key to select "Ch1 Target sp".
17. Press the Up Key and set to 23°C.
18. Press the Scroll Key to select "Ch2 Target sp".
19. Press the Up Key and set to 50%.
20. Press the Scroll Key to select "Duration".
21. Press the Up Key and set to "00.4" (4 minutes).
22. Press the Scroll Key to select "Events".
23. Press the Scroll Key until seventh box, press the Up Key to select Event 1 and 5 and fill box
24. Press the Scroll Key to select "Segment Type".
25. Press the Up Key to select "Time".

26. Press the Scroll Key to select "Ch1 Target sp".
27. Press the Up Key and set to 23°C.
28. Press the Scroll Key to select "Ch2 Target sp".
29. Press the Up Key and set to 50%.
30. Press the Scroll Key to select "Duration".
31. Press the Up Key and set to "00.1" (1 minute).
32. Press the Scroll Key to select "Events".
33. Press the Scroll Key until you reach the seventh box.
Press the Up Key to select Event 5 and 1 and fill the box.
34. Press the Scroll Key to select "Segment Type".
This is Segment 3.
35. Press the Up Key and select "Time".
36. Press the Scroll Key to select "Ch1 Target sp".
37. Press the Up Key and set to 23°C.
38. Press the Scroll Key to select "Ch2 Target sp".
39. Press the Up Key and set to 50%.
40. Press the Scroll Key to select "Duration".
41. Press the Up Key and set to "00.4" (4 minutes).
42. Press the Scroll Key to select "Events".
43. Press the Scroll Key until seventh box, press the Up Key to select Event 1 and 5 and fill box
44. Press the Scroll Key to select "Segment Type".
45. Press the Up Key to select "Time".
46. Press the Scroll Key to select "Ch1 Target sp".
47. Press the Up Key and set to 23°C.
48. Press the Scroll Key to select "Ch2 Target sp".
49. Press the Up Key and set to 50%.
50. Press the Scroll Key to select "Duration".
51. Press the Up Key and set to "00.1" (1 minute).
52. Press the Scroll Key to select "Events".
53. Press the Scroll Key until you reach the seventh box.
Press the Up Key to select Event 5 and 1 and fill the box.
54. Press the Scroll Key to select "Segment Type". This is Segment 4.
55. Press the Up Key and select "Time".
56. Press the Scroll Key to select "Ch1 Target sp".
57. Press the Up Key and set to 23°C.
58. Press the Scroll Key to select "Ch2 Target sp".
59. Press the Up Key and set to 50%.
60. Press the Scroll Key to select "Duration".
61. Press the Up Key and set to "00.4" (4 minutes).
62. Press the Scroll Key to select "Events".
63. Press the Scroll Key until seventh box, press the Up Key to select Event 1 and 5 and fill box
64. Press the Scroll Key to select "Segment Type".
This is Segment 5.
65. Press the Up Key and select "Time".
66. Press the Scroll Key to select "Ch1 Target sp".
67. Press the Up Key and set to 23°C.
68. Press the Scroll Key to select "Ch2 Target sp".
69. Press the Up Key and set to 50%.
70. Press the Scroll Key to select "Duration".
71. Press the Up Key and set to "00.01" (1 minute).
72. Press the Scroll Key to select "Events".
73. Press the Scroll Key until you reach the seventh box.
Press the Up Key to select Event 1 and 5 fill the box.
74. Press the Scroll Key to select "Segment Type". This is Segment 6.
75. Press the Up Key and select "Time".
76. Press the Scroll Key to select "Ch1 Target sp".
77. Press the Up Key and set to 23°C.
78. Press the Scroll Key to select "Ch2 Target sp".
79. Press the Up Key and set to 50%.

80. Press the Scroll Key to select "Duration".
81. Press the Up Key and set to "00.04" (4 minutes).
82. Press the Scroll Key to select "Events".
83. Press the Scroll Key to Select Events 1, 4 and 5 fill the box.
84. Press the Scroll Key to select "Segment Type". This is Segment 7.
85. Press the Up Key and select "Time".
86. Press the Scroll Key to select "Ch1 Target sp".
87. Press the Up Key and set to 55°C.
88. Press the Scroll Key to select "Ch2 Target sp".
89. Press the Up Key and set to 10%.
90. Press the Scroll Key to select "Duration".
91. Press the Up Key and set to "00.05" (5 minutes).
92. Press the Scroll Key to select "Events".
93. Press the Scroll Key until you reach the seventh box.
Press the Up Key to select Event 4 and 5 and fill the box.
94. Press the Scroll Key to select "Segment Type".
This is Segment 8.
95. Press the Up Key and select "Time".
96. Press the Scroll Key to select Ch1 Target sp".
97. Press the Up Key and set to 55°C.
98. Press the Scroll Key to select "Ch2 Target sp".
99. Press the Up Key and set to 10%.
100. Press the Scroll Key to select "Duration".
101. Press the Up Key and set to "00.10" (10 minutes).
102. Press the Scroll Key to select "Events".
103. Select no events.
104. Press the Scroll Key to select "Segment Type".
This is Segment 9.
105. Press the Up Key and select "Time".
106. Press the Scroll Key to select "Ch1 Target sp".
107. Press the Up Key and set to 55°C.
108. Press the Scroll Key to select "Ch2 Target sp".
109. Press the Up Key and set to 10%.
110. Press the Scroll Key to set "Duration".
111. Press the Up Key and set to "00.15" (15 minutes).
112. Press the Scroll Key to select "Events".
113. Press the Scroll Key until you reach the seventh box.
Press the Up Key to select Event 3 fill the box.
114. Press the Scroll Key to select "Segment Type".
This is Segment 10.
115. Press the Up Key to select "time".
116. Press the Scroll Key to select "Ch1 Target sp".
117. Press the Up Key and set to 55°C.
118. Press the Scroll Key to select "Ch2 Target sp".
119. Press the Up Key and set to 10%.
120. Press the Scroll Key to set "Duration".
121. Press the Up Key and set to "02.30" (2 hours 30 minutes).
122. Press the Scroll Key to select "Events".
123. Press the Scroll Key until you reach the third box.
Press the Up Key to select Event 3 and fill the box.
124. Press the Scroll Key to select "Segment Type". This is Segment 11.
125. Press the Up Key and select "Time".
126. Press the Scroll Key to select "Ch1 Target sp".
127. Press the Up Key and set to 50°C.
128. Press the Scroll Key to select "Ch2 Target sp".
129. Press the Up Key and set to 85%.
130. Press the Scroll Key to set "Duration".
131. Press the Up Key and set to "00.05" (5 minutes).
132. Press the Scroll Key to select "Events".

133. Press the Scroll Key until you reach the third box.
Press the Up Key to select Event 2 and 3 and fill the box.
134. Press the Scroll Key to select "Segment Type".
This is Segment 12.
135. Press the Up Key and select "Time".
136. Press the Scroll Key to select "Ch1 Target sp".
137. Press the Up Key and set to 50°C.
138. Press the Scroll Key to select "Ch2 Target sp".
139. Press the Up Key and set to 85%.
140. Press the Scroll Key to set "Duration".
141. Press the Up Key and set to "00.25" (25 minutes).
142. Press the Scroll Key to select "Events".
143. Press the Scroll Key until you reach the third box.
Press the Up Key to select Event 2 and 3 and fill the box.
144. Press the Scroll Key to select "Segment Type".
This is Segment 13.
145. Press the Up Key and select "Time".
146. Press the Scroll Key to select "Ch1 Target sp".
147. Press the Up Key and set to 50°C.
148. Press the Scroll Key to select "Ch2 Target sp".
149. Press the Up Key and set to 85%.
150. Press the Scroll Key to set "Duration".
151. Press the Up Key and set to "20.15" (20 hours 15 minutes).
152. Press the Scroll Key to select "Events".
153. Press the Scroll Key until you reach the third box.
Press the Up Key to select Event 2 and 3 and fill the box.
154. Press the Scroll Key to select "Segment Type".
This is Segment 14.
155. Press the Up Key to select "Go back".
156. Press the Scroll Key to select "Go back seg".
157. Press the Up Key to Select "1" (go back to segment 1).
158. Press the Scroll Key to select "Go back cycles".
159. Press the Up Key to select "5".
It will now repeat Segment 1 to 12, 4 times.
160. Press the Scroll Key to select "Segment Type".
This is Segment 15.
161. Press the Up Key to select "Time".
162. Press the Scroll Key to select "Ch1 Target sp".
163. Press the Up Key and set to 50°C.
164. Press the Scroll Key to select "Ch2 Target sp".
165. Press the Up Key and set to 85%.
166. Press the Scroll Key to select "Duration".
167. Press the Up Key and set to "48.00" (48 hours).
168. Press the Scroll Key to select "Events".
169. Press the Scroll Key until you reach the third box.
Press the Up Key to select Event 2 and 3 and fill the box.
170. Press the Scroll Key to select "Segment Type".
This is Segment 16.
171. Press the Up Key and select "END".
172. The Program can now be run.
173. Press the "Run" Key.
174. Press the Up Key and select "1".
175. Press Run to run Program 1.

CCT PROGRAM

Salt Spray @ 35°C 240 Minutes
Dry @ 60°C 120 Minutes
Humidity @ 42°C 20 + 100 Minutes
REPEAT OK

- 1) Note New programs cannot be entered while a program is running.
- 2) To enter a new program follows the instructions below.
- 3) Press arrow key until **Running reset to stop** appears.
- 4) Press reset to reset the program.
- 5) Press arrow key until **11 Run program** appears.
- 6) Press the Prog key until the flashing * appears.
- 7) Salt Spray 35 Deg. C (240 Mins)
- 8) Press arrow key until **set up new program** appears.
- 9) Press the Prog key.
- 10) Press the arrow key until **15 Set up segment** appears.
- 11) Press Prog key 151 Set up segment Main 1 will show.
- 12) Press arrow key until **152 Set function** appears.
- 13) Press Prog key until the flashing * appears
- 14) Press arrow key until function required is reached, (Salt Spray saturated RH, Temperature Ramp, Temperature Dwell End of Programme)
- 15) Press Prog key to load.
- 16) Press arrow key until **153 Set sub func temp ramp** appears.
- 17) Press Prog key until the flashing * appears
- 18) Press arrow key until function required is reached, Fixed temp.
- 19) Press Prog key to load
- 20) Press arrow key until **154 Set temp** appears
- 21) Press Prog key until the flashing * appears
- 22) Press arrow key until temperature required is reached, 35°C
- 23) Press Prog key to load
- 24) Press arrow key until **154 Set water temp** (Humidifier temperature) appears
- 25) Press Prog key until the flashing * appears
- 26) Press arrow key until temperature required is reached, 45°C
- 27) Press Prog key to load
- 28) Press arrow key until 156 Prog on time continuous appears
- 29) Press Prog key until the flashing * appears
- 30) Press arrow key until time in minutes required is reached, 240 mins (4 hours).
- 31) Press Prog key to load
- 32) Press arrow key **UV Light off** appears **Ignore** this function, as standard cabinets do not have this facility.
- 33) Press arrow key until **Display fog off time** appears
- 34) Press Prog key until the flashing * appears
- 35) Press arrow key until desired function is reached.
- 36) Press Prog key to load
- 37) Press arrow key until **Number of cycles** appears
- 38) Press arrow key until desired no of cycles is reached
- 39) Press Prog key to load
- 40) Ramp up to 60 Deg. C (20 Min)

- 41) Press right arrow key until **151 Set up segment main** appears
42) Press Prog key until the flashing * appears
- 43) Press the right arrow key until **Main 2** appears
44) Press the Prog key to load
45) Press the right arrow key until **152 Set function** appears
46) Press Prog key until the flashing * appears
- 47) Press right arrow key until **Temp ramp** appears
48) Press Prog key to load
49) Press right arrow key until **Set ramp** appear
50) Press Prog key until the flashing * appears
- 51) Press right arrow key until **1.0°C/min** appears
52) Press Prog key to load
53) Press the right arrow key until **154 Set end temp** appears
54) Press Prog key until the flashing * appears
- 55) Press right arrow key until desired temp is set, 60°C
56) Press Prog key to load
- 57) DRY Air 60 Deg. C (100 Min)
- 58) Press right arrow key until **151 Set up segment main 2** appears
59) Press Prog key until the flashing * appears
- 60) Press right arrow key until **Main 3** appears
61) Press Prog key to load
62) Press right arrow key until **152 Set function** appears
63) Press Prog key until the flashing * appears
- 64) Press right arrow key until **Temp dwell** appears
65) Press Prog key to load
66) Press right arrow key until **153 Cycle time** appears
67) Press Prog key until the flashing * appears
- 68) Press right arrow key to set desired time, 1 hour 40 minutes (2 hours minus the ramp up time) 100 minutes
69) Press Prog key to load
70) Press right arrow key until **154 Set temp** appears
71) Press Prog key until the flashing * appears
- 72) Press right arrow key until desired temp is set, 60°C
73) Press Prog key to load
- 74) Humidity (Wet) 42 Deg. C (120 Min) 3
75) Press right arrow key until **151 Set up segment main 3** appears
76) Press Prog key until the flashing * appears
- 77) Press right arrow key until **Main 4** appears
78) Press Prog key to load
79) Press the right arrow key until **152 Set function** appears
80) Press Prog key until the flashing * appears
- 81) Press right arrow key until **Saturated RH** appears
82) Press Prog key to load
83) Press right arrow key until **153 Set sub func** appears

- 84) Press Prog key until the flashing * appears
- 85) Press the right arrow key until **Fixed temp** appears
- 86) Press Prog key to load
- 87) Press right arrow key until **154 Set temp** appears
- 88) Press Prog key until the flashing * appears
- 89) Press right arrow key until the desired temp appears 42°C
- 90) Press Prog key to load
- 91) Press right arrow key until **155 Cycle time** appears
- 92) Press Prog key until the flashing * appears
- 93) Press right arrow key to set desired time 120 mins (2 hours)
- 94) Press Prog key to load
- 95) End of Prog
- 96) Press arrow key until **151 Set up segment main 4** appears
- 97) Press Prog key until the flashing * appears
- 98) Press right arrow key until **Main 5** appears
- 99) Press Prog key to load
- 100) Press right arrow key until **152 Set function** appears
- 101) Press Prog key until the flashing * appears
- 102) Press right arrow key until **End of prog** appears
- 103) Press Prog key to load
- 104) Press left arrow key until **151 Set up segment main 5** appears
- 105) SAVING THE PROGRAMME
- 106) You now will need to save the program in a slot 1 to 7. (Our Choice is Pos 7)
- 107) Press arrow key until 151 Set up segment main (number of last segment) appear
- 108) Press the Reset Key **15 Setup seg** will appear
- 109) Press arrow key until **Save program at pos:7** appears
- 110) Press Prog key until the flashing * appears
- 111) Press arrow key until desired position is reached. **Note:** Please remember the position of the program as when saved any programs at that position will be overwritten.
- 112) Press Prog key to load **Saving please wait** displayed this will last for 10 seconds
- 113) Press arrow key until **set up new program** appears
- 114) Press Prog key until the flashing * appears
- 115) Press arrow key until **11 Run program** appears
- 116) Press Prog key to load
- 117) Press arrow key until **load program** appears
- 118) Press Prog key until the flashing * appears
- 119) Press arrow key until **load program at pos:7** appears
- 120) Press Prog key to load
- 121) Press arrow key until **13 stopped Prog to run** appears
- 122) Press Prog key to run program

8. CHECK LIST

1. The cabinet lid seals correctly i.e. sufficient water in trap and the seal is not damaged
2. Humidity level required is set on the program controller.
3. Temperature level required is set on the program controller.
4. Water reservoir is connected and the pipe is not twisted or folded which could restrict the flow.
5. The water reservoir is filled with de-ionised water and the filter is in position.
6. The peristaltic pump head is rotating and there is the required flow showing on the flowmeter.
7. The drains from the cabinet are connected.

9. SCHEDULED MAINTENANCE

1. During testing the water from the water seal evaporates. It is naturally replaced by droplets running down the apex roof into the water trough.

After prolonged testing it is recommended that the water trough is emptied and replenished with fresh water.

2. After approximately 1000 hours it is recommended that the tubing in the pump head is replaced (see below).

The silicone tubing used is a tough tubing, however, if it is not replaced at the suggested intervals it will eventually wear and split, depositing salt solution onto the pump motor and surrounding area.

3. At least once every 10 weeks the disposable salt solution filter (Ref Code CW5550) in the salt solution reservoir should be replaced. It may be necessary to replace this filter more frequently depending on the quality of water used.

It is policy for our service engineers to exercise the above procedure should you employ our service and calibration contract offered on an annual basis 12 months after delivery of your cabinet.

HOW TO CHANGE THE TUBING ON A PERISTALTIC PUMP

1. Twist the pump cover 30° anti-clockwise until it unlocks. See Fig. 2
2. Remove pump cover from grey pump housing. See Fig. 3
3. Unclip grey clips from bottom of inside of pump cover. See Fig. 4
4. Remove tube and grey locking clips from pump cover. See Fig. 5
5. Remove grey locking clips from tubing. See Fig. 5
6. Unscrew blue locking caps on pump panel to allow old tube to be pulled off. Remove old tubing and discard. Clean off old dust or debris from pump head. See Fig. 6
7. Cut new length of silicone tube at least 600mm long. See Fig. 7
8. Place flat blade screwdriver in location position in centre white pump rotation drum and turn slowly clockwise to feed the new tube into the channel between the pump rotation drum and the pump cover. See Fig. 7
9. Attach grey locking clip onto tube on both sides and push back into position on pump cover. Ensure the correct fitment of the locking clips when attaching to the pump head, as incorrect fitment will damage the pump and invalidate any warranty. See Fig. 7 / 8
10. Put blue locking caps back onto the tube and reconnect the tube onto the blue fittings on the pump panel and tighten. See Fig. 8, 9 & 10

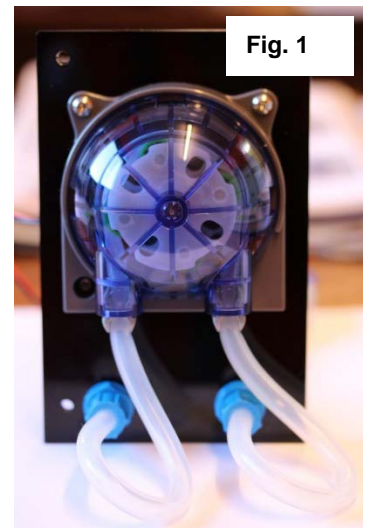
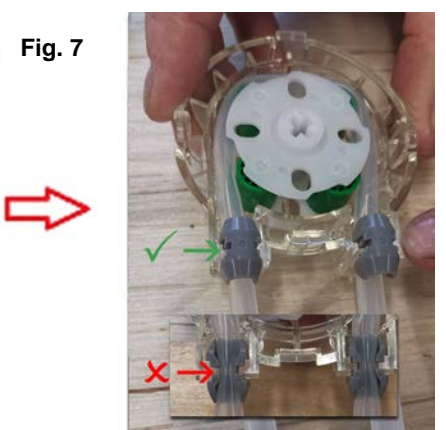
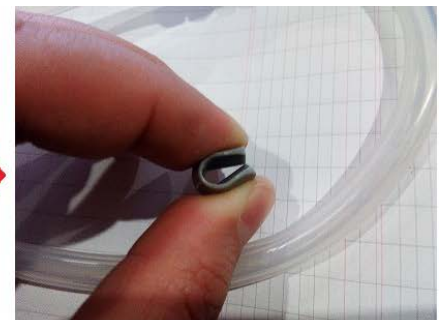
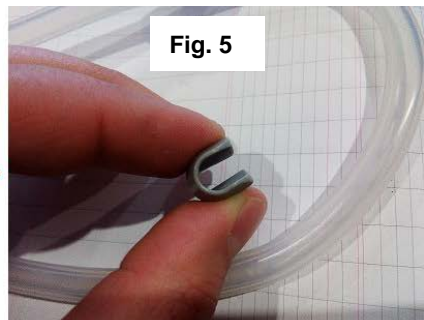
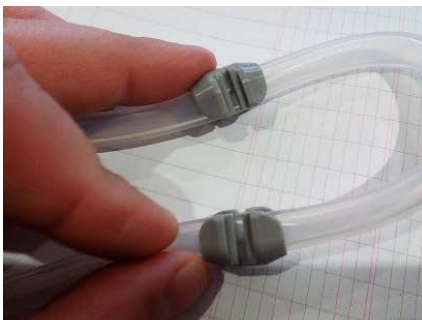
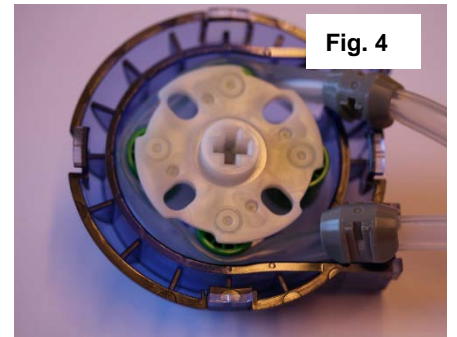
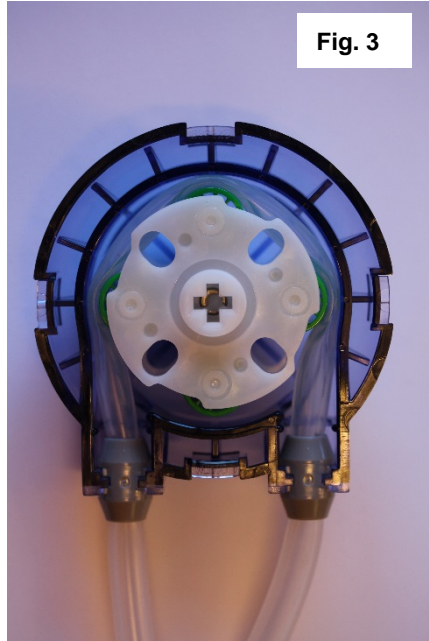
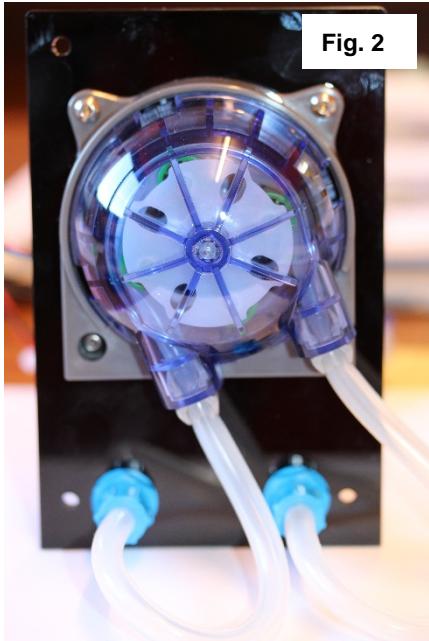

Fig. 1

11. Reposition pump cover locating the centre onto the white plastic drive shaft and lock cover by turning clockwise onto the grey housing. See Fig. 11 & 12.

12. Finished! See Fig. 1



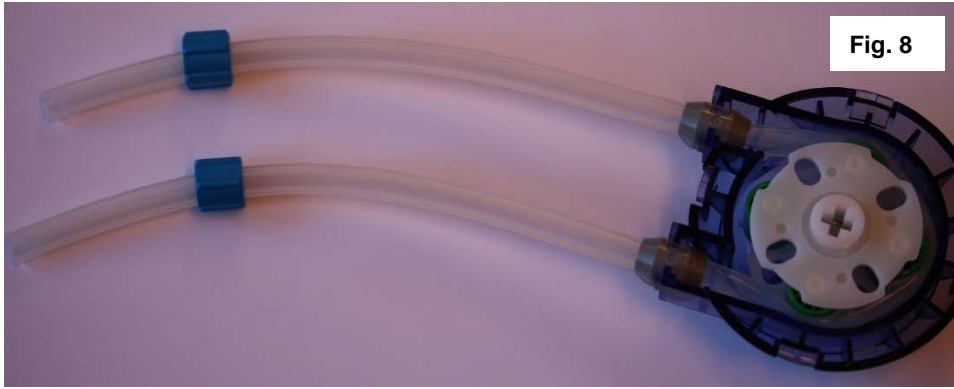

Fig. 8



Fig. 9



Fig. 10

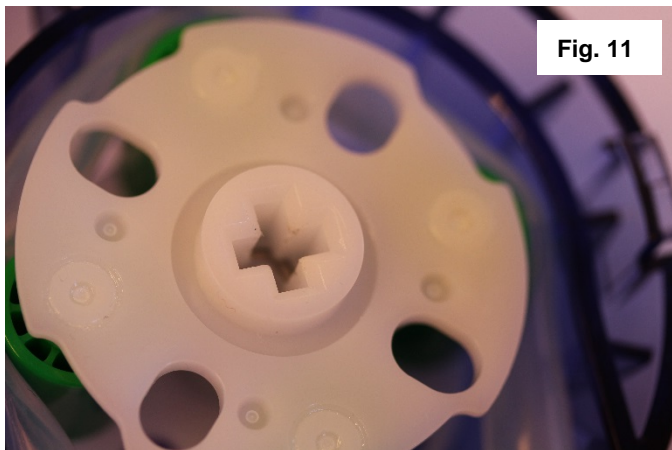

Fig. 11

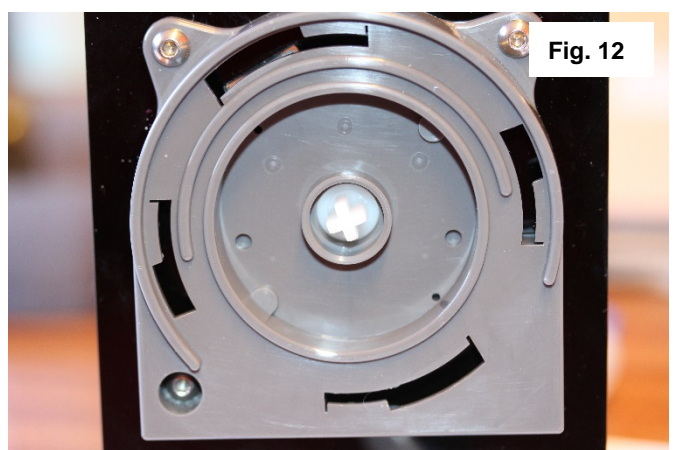

Fig. 12

10. TROUBLE SHOOTING

Below are listed several helpful diagnosis hints, should you experience any errors that may interfere with your testing.

NO HUMIDITY

1. Remove the far trunking between the cabinet and condenser unit and observe if a mist is being generated. It will flow from the condenser unit
2. Check that the air and water connections between the cabinet and condenser unit are connected and turned on at the rear of the cabinet, also to the cabinet services panel
3. Check that VH has been selected through the controller. Event 3

NO HEAT

1. Check that the power to the cabinet is switched on.
2. Check the temperature setting (degrees centigrade) set in the program controller is set at the required level and compare to the actual reading in the chamber.

11. GAS SPRINGS - SAFETY REQUIREMENTS

Gas Springs are filled with Nitrogen at very high pressures, and under no circumstances should they be opened, tampered with, or subjected to excessive heat or tension.

Gas Springs should always be treated with respect in the knowledge of the pressure internally.

As a pressurised item, it is recommended that they be returned to the supplier for safe disposal at the end of their useful life.

As the nature of a Gas Spring is to lose its force over a long period of time, it is advisable to periodically check its ability to operate as initially intended, preferably forming part of planned maintenance structure. Replace if, and when, necessary.

INSTALLATION INSTRUCTIONS

For standard compression Gas Springs, we advise the use of ball joints to alleviate possible side loads.

Generally fit with piston rod down, preferably within 60 degrees to the vertical, and avoid the spring travelling through a large arc. It is advisable to keep the spring in a single plane of movement. Failure to adhere to this advice may result in reduced life of the Gas Spring.

Further information and advice can be obtained from:



C&W Specialist Equipment
Unit 2, Burnside Court
Brunel Road
Leominster
Herefordshire
HR6 0LX United Kingdom

Phone: +44 (0) 2039 3635 65
E-mail: sales.service@cw-spec.com

www.cw-spec.com